

# QUICK EXHAUST VALVES

SQE, SQE1, SQE2,  
QE2, QE3, QE4, QE5

## Symbol

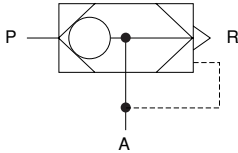

## Specifications

Item	Model	SQE	SQE1	SQE2	QE2	QE3	QE4	QE5
Port size	P, A	M5×0.8	Rc1/8	Rc1/4	Rc1/4	Rc3/8	Rc1/2	Rc3/4
	R	0.8	Rc1/4		Rc3/8		Rc3/4	
Effective area mm <sup>2</sup>	P→A	2.5	21	30	50	60	120	140
	A→R	2.5	28	37	50	60	140	160
Flow coefficient Cv	P→A	0.12	0.91	1.32	2.5	2.8	5.8	6.8
	A→R	0.12	1.23	1.66	2.5	2.8	6.8	7.8
Media		Air						
Operating pressure range	MPa (kgf/cm <sup>2</sup> ) [psi.]	0.03~0.9 (0.3~9.2) [4~131]	0.07~0.9 {0.7~9.2} [10~132]					
Proof pressure	MPa (kgf/cm <sup>2</sup> ) [psi.]	1.35 {13.8} [196]						
Operating temperature range (atmosphere and media)	°C [°F]	5~60 [41~140]						
Maximum operating frequency	Hz	10						
Lubrication		Not required						
Mass	g [oz.]	10 [0.35]	80 [2.82]	120 [4.23]	430 [15.17]			

## Operating Principles, Major Parts and Materials

When used as a quick exhaust valve

When used as a shuttle valve

● Air supply condition

● Air supply condition (A)

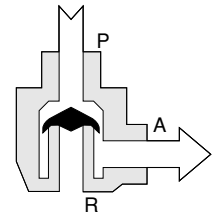
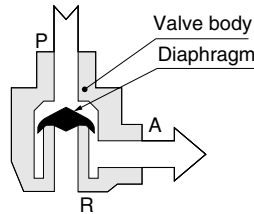

● Exhaust condition

● Air supply condition (B)

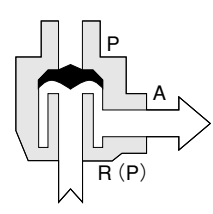
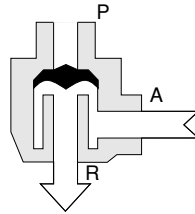

Parts	Materials	
	SQE, SQE1, SQE2	QE2, QE3, QE4, QE5
Body	Zinc die-casting (SQE is brass)	Aluminum alloy
Diaphragm	Synthetic rubber	Urethane rubber
Port cover	—	Aluminum alloy
O-ring	—	Nitril rubber

## Order Codes

**SQE**  Port size  
Blank : M5×0.8  
1 : Rc1/8  
2 : Rc1/4

**QE**  Port size  
2 : Rc1/4  
3 : Rc3/8  
4 : Rc1/2  
5 : Rc3/4

## Dimensions (mm)

● SQE

● SQE1  
● SQE2

● QE2  
● QE3

● QE4  
● QE5

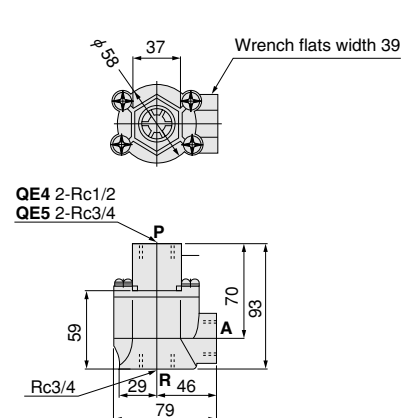
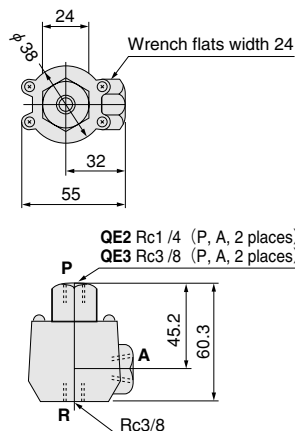
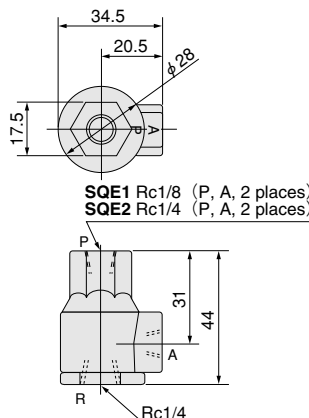
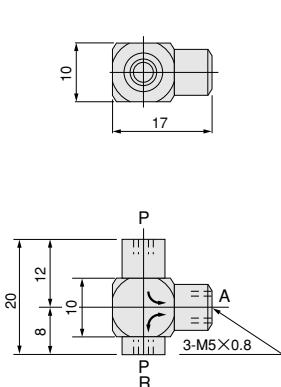

# Flow Rate

## SQE

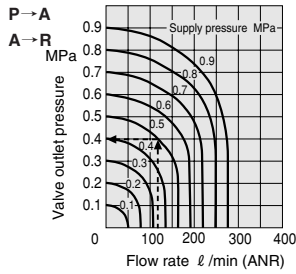

1MPa = 145psi., 1 l /min = 0.0353ft.<sup>3</sup>/min.

### How to read the graph

When the supply pressure is 0.5MPa [73psi.] and the flow rate is 125 l /min [4.41ft.<sup>3</sup>/min.] (ANR), the valve outlet pressure becomes 0.4MPa [58psi.].

## SQE1

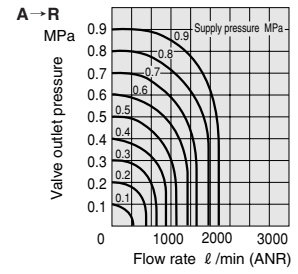
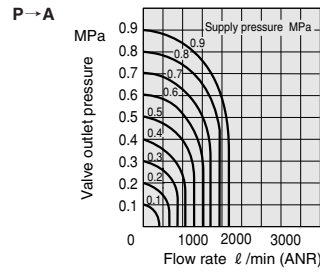

## SQE2

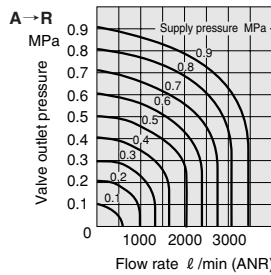
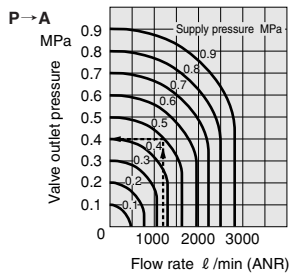

## QE2

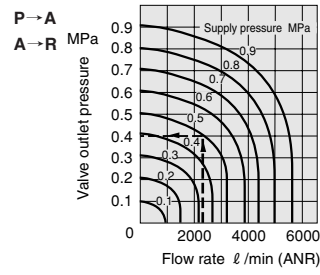

## QE3

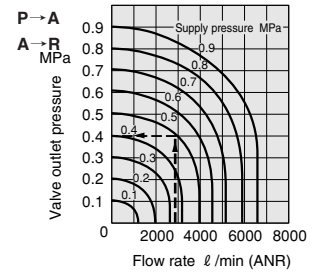

## QE4

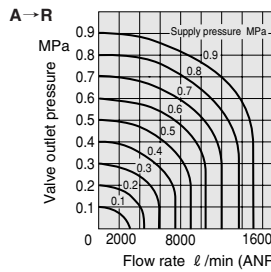
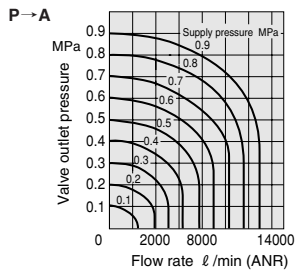

## QE5

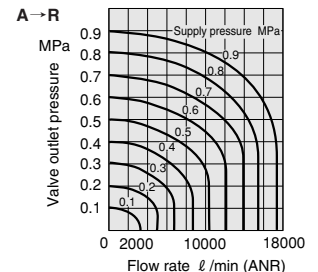
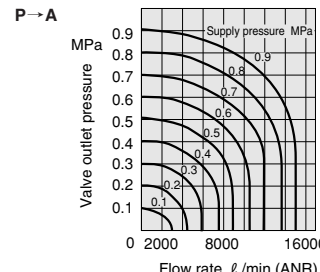

# Time Required for Air Supply and Exhaust

Tank volume l [ft. <sup>3</sup> ]	Air supply and exhaust pressure MPa [kg/cm <sup>2</sup> ] [psi.]	SQE1	SQE2	QE2	QE3	QE4	QE5
1.64 [0.0579]	0 → 0.55 [5.6] [80]	0.35	0.33	0.17	0.13	—	—
	0.7 [7.1] [102] → 0.14 [1.4] [20]	0.32	0.22	0.16	0.10	—	—
16.4 [0.579]	0 → 0.55 [5.6] [80]	3.5	2.3	1.80	1.50	0.537	0.508
	0.7 [7.1] [102] → 0.14 [1.4] [20]	3.2	2.2	1.50	0.90	0.440	0.417

Note: Air supply time is the time required to fill a tank with 0.7MPa [102psi.] air from a pressure level of 0 to 0.55MPa [80psi.].  
Exhaust time is the time required to reduce a tank pressure of 0.7MPa [102psi.] down to 0.14MPa [20psi.].

QUICK EXHAUST VALVES

S

