

Parallel Type Linear Guide Specification Air Hands

L Hands

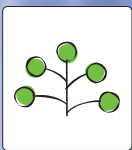

Koganei Brand

All products

RoHS-compliant



Optimum for space-saving

Uses our independently developed mechanism to achieve the **L-shaped hand**.

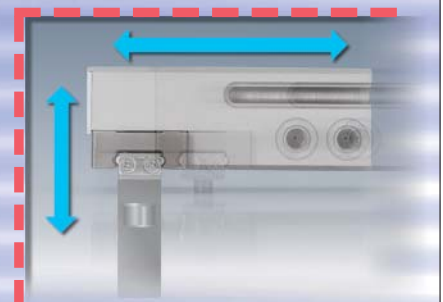

Parallel Type Linear Guide Specification

L Hands

Environmentally friendly **RoHS** compliant product!

Cylinder Bore Size

- 8**
[0.315 in.]
- 10**
[0.394 in.]
- 16**
[0.630 in.]
- 20**
[0.787 in.]
- 25**
[0.984 in.]

- Thin**
- Lightweight**
- Compact**
- Almost twice the gripping force of conventional models

With a new cam drive method differing from conventional air hands, the levers can be driven perpendicular to the cylinder axis.

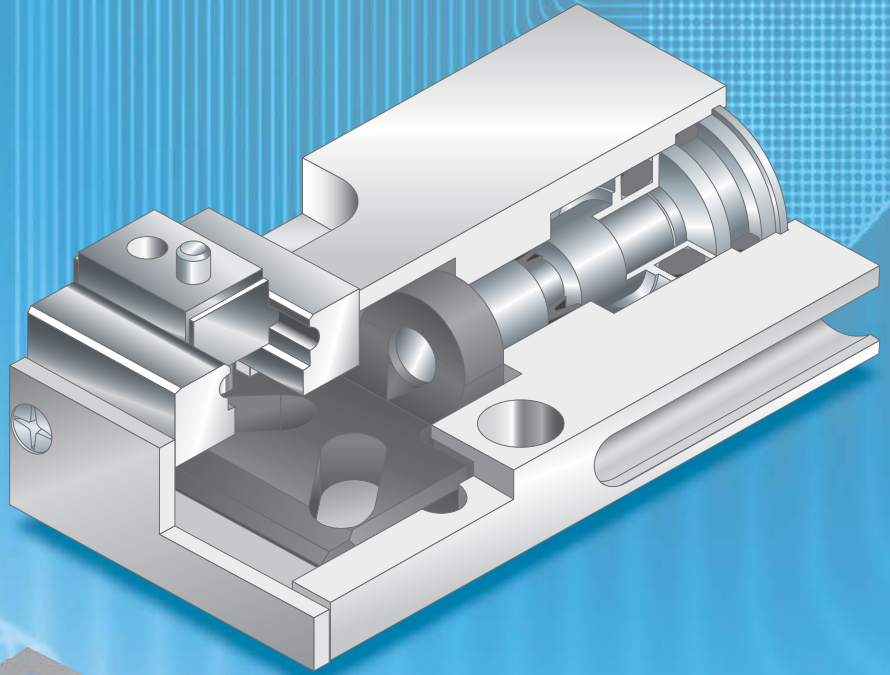

Optimum for pick and place in tight spaces.



CONTENTS	
Features	1
Safety Precautions	2
Handling instructions and Precautions	5
Specifications, Inner Construction, and Major Parts and Materials	8
Order Codes, Dimensions	9
Sensor Switches	12

Safety Precautions (L Hands)

Always read these precautions carefully before use.





Before selecting and using the products, please read all the Safety Precautions carefully to ensure proper product use.

The Safety Precautions shown below are to help you use the product safely and correctly, and to prevent injury or damage to you, other people, and assets beforehand.

Follow the Safety Precautions for: ISO4414 (Pneumatic fluid power—Recommendations for the application of equipment to transmission and control systems), JIS B 8370 (Pneumatic system regulations)

The directions are ranked according to degree of potential danger or damage:

“DANGER!”, “WARNING!”, “CAUTION!”, and “ATTENTION!”

 DANGER	Expresses situations that can be clearly predicted as dangerous. If the noted danger is not avoided, it could result in death or serious injury. It could also result in damage or destruction of assets.
 WARNING	Expresses situations that, while not immediately dangerous, could become dangerous. If the noted danger is not avoided, it could result in death or serious injury. It could also result in damage or destruction of assets.
 CAUTION	Expresses situations that, while not immediately dangerous, could become dangerous. If the noted danger is not avoided, it could result in light or semi-serious injury. It could also result in damage or destruction of assets.
 ATTENTION	While there is little chance of injury, this content refers to points that should be observed for appropriate use of the product.

■ This product was designed and manufactured as parts for use in General Industrial Machinery.

■ In the selection and handling of the equipment, the system designer or other person with fully adequate knowledge and experience should always read the Safety Precautions, Catalog, Owner's Manual and other literature before commencing operation. Making mistakes in handling is dangerous.

■ After reading the Owner's Manual, Catalog, etc., always place them where they can be easily available for reference to users of this product.

■ If transferring or lending the product to another person, always attach the Owner's Manual, Catalog, etc., to the product where they are easily visible, to ensure that the new user can use the product safely and properly.

■ The danger, warning, and caution items listed under these “Safety Precautions” do not cover all possible cases. Read the Catalog and Owner's Manual carefully, and always keep safety first.

DANGER

- Do not use the product for the purposes listed below:
 1. Medical equipment related to maintenance or management of human lives or bodies.
 2. Mechanical devices or equipment designed for the purpose of moving or transporting people.
 3. Critical safety components in mechanical devices.This product has not been planned or designed for purposes that require advanced stages of safety. It could cause injury to human life.
- Do not use the product in locations with or near dangerous substances such as flammable or ignitable substances. This product is not explosion-proof. It could ignite or burst into flames.
- When mounting the product and workpiece, always firmly support and secure them in place. Dropping or falling the product or improper operation could result in injury.
- Persons who use a pacemaker, etc., should keep a distance of at least 1 meter [3.28 ft.] away from the product. There is a possibility that the pacemaker will malfunction due to the strong magnet built into the product.
- Never attempt to remodel the product. It could result in abnormal operation leading to injury, electric shock, fire, etc.
- Never attempt inappropriate disassembly, assembly or repair of the product relating to basic inner construction, or to its performance or to functions. It could result in injury, electric shock, fire, etc.
- Do not splash water on the product. Spraying it with water, washing it, or using it underwater could result in malfunction of the product leading to injury, electric shock, fire, etc.
- While the product is in operation, avoid touching it with your hands or otherwise approaching too close. In addition, do not make any adjustments to the interior or to the attached mechanisms (sensor switch mounting location, disconnection of piping tubes or plugs, etc.).
The actuator can move suddenly, possibly resulting in injury.
- When operating the product, always install speed controllers, and gradually loosen the needle valve from a choked state to adjust the speed increasing. Failure to make this adjustment could result in sudden movements, putting lives at risk.

WARNING

- Do not use the product in excess of its specification range. Such use could result in product breakdowns, function stop, damage, or drastically reduce the operating life.
- Before supplying air or electricity to the device and before starting operation, always conduct a safety check of the area of machine operation. Unintentional supply of air or electricity could possibly result in electric shock, or in injury caused by contact with moving parts.
- Do not touch the terminals and the miscellaneous switches, etc., while the device is powered on. There is a possibility of electric shock and abnormal operation.
- Do not throw the product into fire. The product could explode and/or release toxic gases.
- Do not sit on the product, place your foot on it, or place other objects on it. Accidents such as falling and tripping over could result in injury. If the product falls or is dropped it could result in injury, or also damage or break the product resulting in abnormal or erratic operation, or runaway, etc.
- When conducting any kind of operation for the product, such as maintenance, inspection, repair, or replacement, always turn off the air supply completely and confirm that residual pressure inside the product or in piping connected to the product is zero before proceeding. In particular, be aware that residual air will still be in the air compressor or air storage tank. The actuator could abruptly move if residual air pressure remains inside the piping, causing injury.
- Do not use the actuator for equipment whose purpose is absorbing the shocks and vibrations of mechanical devices. It could break and possibly result in injury or in damage to mechanical devices.
- Avoid scratching the cords for the sensor switch lead wires, etc. Letting the cords be subject to scratching, excessive bending, pulling, rolling up, or being placed under heavy objects or squeezed between two objects, may result in current leaks or defective continuity that lead to fire, electric shock, or abnormal operation.
- Do not subject sensor switches to an external magnetic field during actuator operation. Unintended movements could result in damage to the equipment or in personal injury.

- Use the product within the recommended load and operating frequency specifications. Attempting to use it beyond the recommended load and operating frequency specifications could damage the lever, etc., which could result in damage to the equipment or personal injury. It could also drastically reduce the product's operating life.
- Use safety circuits or design systems that prevent damage to machinery or injury to personnel when the machine is shut down due to an emergency stop or electrical power failure.
- Install relief valves, etc., to ensure that the actuator does not exceed its rated pressure when such pressure is rising due to external forces on the actuator. Excessive pressure could lead to a breakdown and damage.
- In initial operations after the equipment has been idle for 48 hours or more, or has been in storage, there is a possibility that contacting parts may have stuck together, resulting in equipment operation delays or sudden movements. For these initial operations, always run a test operation before use to check that operating performance is normal.



CAUTION

- Do not use the product in locations that are subject to direct sunlight (ultraviolet rays), dust, salt, iron powder, high humidity, or in the media and/or the ambient atmospheres that include organic solvents, phosphate ester type hydraulic oil, sulfur dioxide, chlorine gas, acids, etc. It could lead to early shutdown of some functions or a sudden degradation of performance, and result in a reduced operating life. For the materials, see the Major Parts and Materials.
- When installing the product, leave room for adequate working space around it. Failure to ensure adequate working space will make it more difficult to conduct daily inspections or maintenance, which could eventually lead to system shutdown or damage to the product.
- Do not bring floppy disks or magnetic media, etc., within 1 meter [3.28 ft.] of the product. There is the possibility that the data on the floppy disks will be destroyed due to the magnetism of the magnet.
- Do not use the sensor switch in locations subject to large electrical currents or strong magnetic fields. It could result in erratic operation. In addition, do not use magnetized materials for the mounting brackets. The magnetism could leak, possibly resulting in erratic operation.
- Do not place the product too closely to magnets. Placing it near magnets or in locations subject to large strong magnetic field will cause erratic operation of sensor switches due to magnetization of the main body and lever, or cause failure by adherence of iron powder, etc.
- Never use other companies' sensor switches with these products. It could possibly cause erratic operation or runaway.
- Do not scratch, dent, or deform the actuator by climbing on the product, using it as a scaffold, or placing objects on top of it. It could lead to damaged or broken products that result in operation shutdown or degraded performance.
- Always post an "operations in progress" sign for installations, adjustments, or other operations, to avoid unintentional supplying of air or electrical power, etc. Such accidental supplies may cause electrical shock, or sudden activation of the actuator that could result in physical injury.
- Do not pull on the cords of the lead wires, etc., of the sensor switches mounted on the actuators, grab them when lifting or carrying, or place heavy objects or excessive loads on them. Such action could result in current leaks or defective continuity that lead to fire, electric shock, or abnormal operation.



ATTENTION

- When considering the possibility of using this product in situations or environments not specifically noted in the Catalog or Owner's Manual, or in applications where safety is an important requirement such as in an airplane facility, combustion equipment, leisure equipment, safety equipment and other places where human life or assets may be greatly affected, take adequate safety precautions such as the application with enough margins for ratings and performance or fail-safe measure. Be sure to consult us with such applications.
- Always check the Catalog and other reference materials for product wiring and piping.
- Use a protective cover, etc., to ensure human bodies not to come into direct contact with the operating portion of mechanical devices, etc.
- Do not control in a way that would cause a workpiece to fall during power failure. Take control measures so that they prevent the table or workpieces, etc., from falling during a power failure or emergency stop of the mechanical devices.
- When handling the product, wear protective gloves, safety glasses, safety shoes, etc., to keep safety.
- When the product can no longer be used, or is no longer necessary, dispose of it appropriately as industrial waste.
- Pneumatic equipment can exhibit degraded performance and function over its operating life. Always conduct daily inspections of the pneumatic equipment, and confirm that all requisite system functions are satisfied, to prevent accidents from happening.
- For inquiries about the product, consult your nearest Koganei sales office or Koganei overseas department. The address and telephone number is shown on the back cover of this catalog.



OTHERS

- Always observe the following items.
 1. When using this product in pneumatic systems, always use genuine KOGANEI parts or compatible parts (recommended parts).
When conducting maintenance and repairs, always use genuine KOGANEI parts or compatible parts (recommended parts). Always observe the required methods and procedure.
 2. Do not attempt inappropriate disassembly or assembly of the product relating to basic configurations, or its performance or functions.

Koganei cannot be responsible if these items are not properly observed.



Design and selection

Warning

1. Check the specifications.

As use of this product over the specified ranges of voltage, current, temperature, shocks, etc., could result in a breakdown or abnormal operation, always read the specifications carefully to ensure correct use.

2. Avoid mounting actuators in close proximity.

Mounting two or more actuators with sensor switches in close proximity could result in erratic operation of the sensor switches, due to magnetic field interference with the system.

3. Caution about sensor switch ON time for positioning detection at intermediate stroke position.

Take caution that if the sensor switch is mounted at an intermediate position of the actuator stroke for detection of the piston travel, the sensor switch actuation time may be too short when the actuator speed is very rapid, so that the load (programmable controller, etc.) may fail to activate. Maximum cylinder speed for positioning detection

$$V \text{ (mm/s) [in./sec.]} = \frac{\text{Sensor switch operating range (mm) [in.]}}{\text{Time required for activating load (ms)}} \times 1000$$

4. Keep wiring as short as possible.

The solid state sensor switch lead wire length should be within 30m [98ft.] as stipulated in the EN standards.

5. Avoid repeated or excessive bending or pulling of lead wires.

Applying repeated bending stress or tension force on the lead wire could result in wire breakage.

6. Check for leakage current.

Two-lead wire solid state sensor switches produce leakage current to activate their internal circuits, and the current passes through a load even when in the turned-off condition. Ensure they satisfy the following inequality.

$$\text{Input off current of programmable controller} > \text{Leakage current}$$

If the above inequality cannot be satisfied, select a 3-lead wire solid state sensor switch, instead. Also note that parallel connection of a total of *n* sensor switches will multiply the amount of leakage current by *n* times.

Caution

1. Check for sensor switch internal voltage drop.

Series connection of 2-lead wire solid state sensor switches causes increasing internal voltage drop, and the load may fail to activate. A total of *n* sensor switches will lead to *n* times the internal voltage drop. Ensure that the system satisfies the following inequality.

$$\text{Supply voltage} - \text{Internal voltage drop} \times n > \text{Minimum operating voltage for load}$$

In relays with rated voltage of less than DC24V, check to see whether the above inequality is satisfied, even in the case of *n* = 1.

2. Do not use our sensor switches with other companies' actuators.

The sensor switches are designed for use with Koganei actuators only. Use with other companies' actuators could lead to abnormal operation.



Installation and adjustment

Warning

1. Do not apply an external magnetic field to the sensor switch while the actuator is in operation.

An unintended movement could result in damage to the equipment or in personal injury.

Caution

1. Ensure a safe installation environment for the actuators with sensor switches.

Do not use the sensor switch in locations subject to large electrical currents or strong magnetic fields. It could result in erratic operation. In addition, do not use magnetized materials for the mounting brackets. The magnetism could leak, possibly resulting in erratic operation.

2. Install sensor switches in the center of their operating range.

Adjust the mounting position of a sensor switch so that the piston stops in the center of its operating range (the range while the sensor turns ON). Operations will be unstable if mounted at the end of the operating range (at the boundary near ON or OFF). Also be aware that the operating range will vary with changes in temperature.

3. Follow the tightening torque of sensor switches when mounting.

Over-tightening beyond the allowed tightening torque may damage the mounting threads, mounting brackets, sensor switches, etc. In addition, insufficient tightening torque could cause the sensor switch installed position to be changed, resulting in operation instability. For the tightening torque, follow the instructions on p.14.

4. Do not carry the actuator grabbing its sensor switch lead wires.

After mounting a sensor switch to an actuator, do not grab and lift the lead wires to carry the actuator. Never do this, as it could result in lead wire disconnections, and could also apply stress to the interior of the sensor switch, resulting in breakage of internal elements.

5. Do not drop sensor switches, or bump them against others.

During handling of sensor switches, do not apply excessive shocks (294.2 m/s² [30 G] or larger) such as hitting, dropping, or bumping.

In reed sensor switches, the contact reed may be activated unintentionally, causing it to send or break sudden signals. It may also cause changes in the contact distance that lead to changes in sensor switch sensitivity and result in erratic operation. Even if the sensor switch case is undamaged, the inner parts of the sensor switch may suffer breakdown or cause erratic operation.

Safety Precautions (Sensor Switches)



Wiring

Danger

1. Avoid letting moving objects near sensor switches come into contact with them.

When the actuators with sensor switches are moving, or when moving objects are nearby, do not let them come into contact each other. In particular, lead wires could become worn out or damaged, causing operating instability in the sensor switch. In the worst case, it could result in current leaks or electrical shocks.

2. Always turn off the power supply for wiring work.

Conducting wiring work while the power is on could result in electric shock. Also, incorrect wiring could damage sensor switches in an instant. Turn on the power only after the wiring work is completed.

Warning

1. Check the Catalog, etc., to ensure that the sensor switch wiring is correctly connected.

Miswiring could result in abnormal operation.

2. Do not share the same wiring with power or high voltage lines.

Avoid wiring in parallel to or shared with power or high voltage lines in a conduit. The sensor switch or control circuit may suffer electric noise that results in erratic operation.

3. Avoid repeated or excessive bending or pulling of lead wires.

Applying repeated bending stress or tension force on the lead wire could result in wire breakage.

4. Check polarity in the wiring.

In polarity (+, -, output) specified sensor switches, make sure that wiring connections are correct. The wrong polarity could result in damage to sensor switches.

Caution

1. Avoid short circuiting the loads.

Turning a sensor switch on while the load is short-circuited causes overcurrent, which will damage the sensor switch in an instant.

Example of short-circuited load: Sensor switch's output lead wire is directly connected to the power supply.

Handling Instructions and Precautions



General precautions

Media

1. Use air for the media. For the use of any other media, consult us.
2. Air used for the L Hands should be clean air that contains no deteriorated compressor oil, etc. Install an air filter (filtration of a minimum 40 µm) near the L Hands or valve to remove collected liquid or dust. In addition, drain the air filter periodically.

Piping

1. In piping connection with the L Hands, flush the tube completely (by blowing compressed air) before piping. Intrusion of machining chips, sealing tape, rust, etc., generated during plumbing could result in air leaks and other defective operations.
2. When screwing in piping or fittings to the L Hands, tighten to the appropriate tightening torque shown below.

Connecting thread	Tightening torque N·m [in·lbf]
M3 × 0.5	0.6 [5.3]
M5 × 0.8	1.6 [14.2]

Lubrication

Cylinder portion

The product can be used without lubrication, if lubrication is required, use Turbine Oil Class 1 (ISO VG32) or equivalent. Avoid using spindle oil or machine oil.

Lever slide portion

The product can be used without lubrication, if lithium-based grease or urea-based grease is applied periodically, it will increase the product's operating life.

Atmosphere

When using in locations subject to dripping water, dripping oil, etc., use something to cover and protect the unit.

Replacement parts

For some models, the seal materials can be replaced by similar materials. Note, however, that seal kits not designated by Koganei cannot be used. Moreover, undesignated parts cannot be used for replacement. For details, consult us.



Selection

Effective gripping force

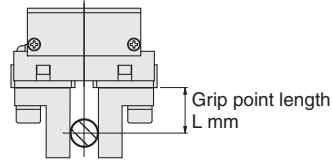

--- : Open side
 — : Closed side

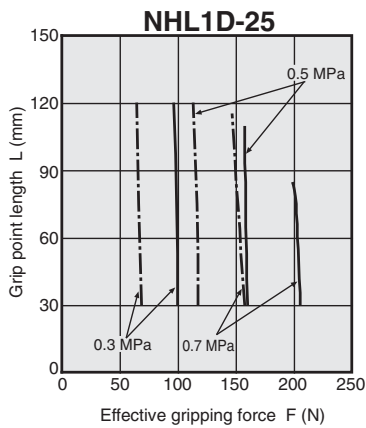
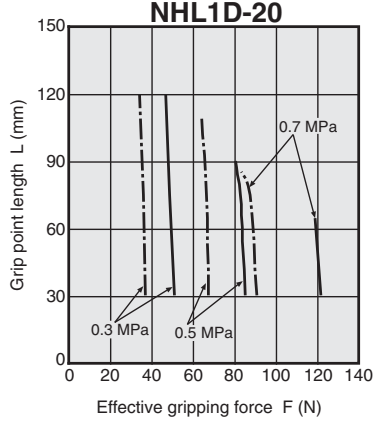
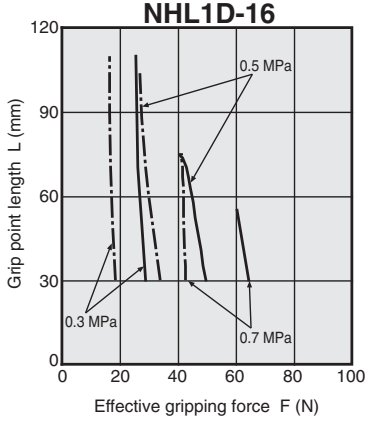
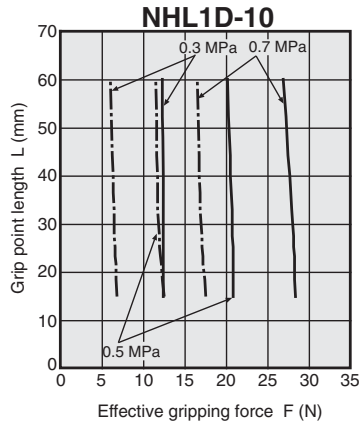
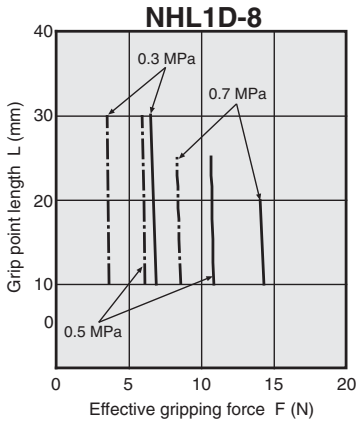

1 mm = 0.0394 in.
 1 N = 0.225 lbf.
 1 MPa = 145 psi.

Gripping point limit range

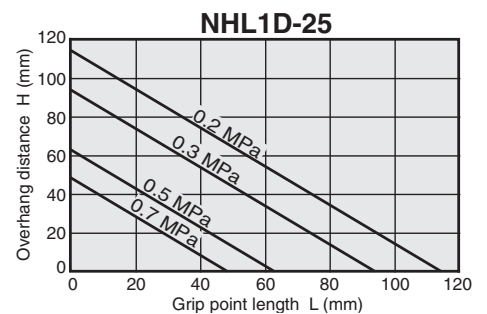
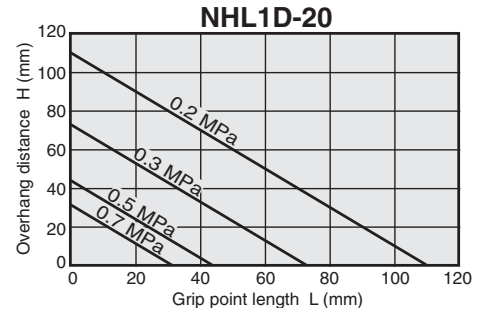
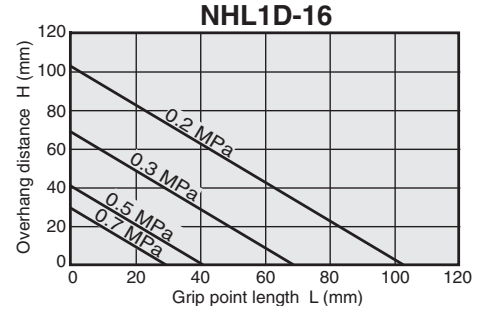
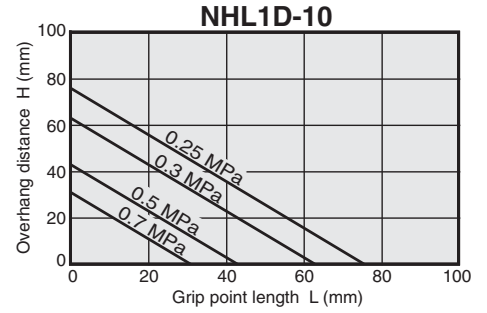
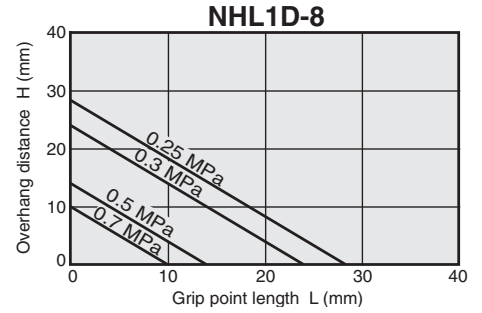
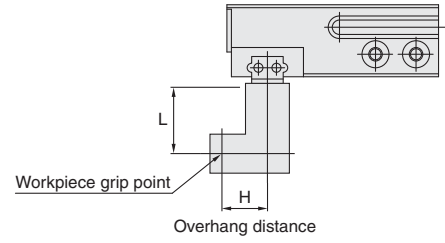

1 mm = 0.0394 in., 1 MPa = 145 psi.

Handling Instructions and Precautions

Allowable load and allowable moment

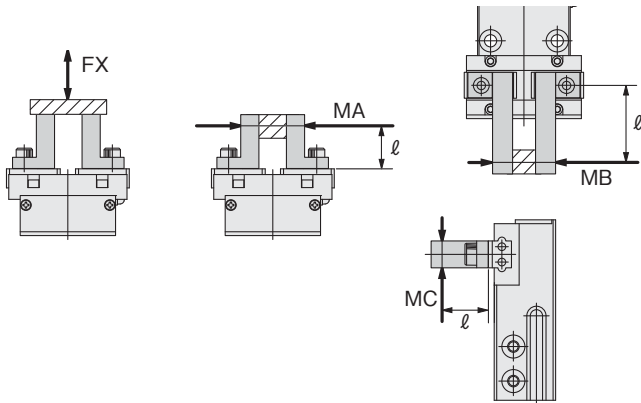

Model	Load and moment FX N [lbf.]	MA N·m [in·lbf]	MB N·m [in·lbf]	MC N·m [in·lbf]
NHL1D-8	12 [2.7]	0.04 [0.35]	0.04 [0.35]	0.04 [0.35]
NHL1D-10	60 [13.5]	0.3 [2.7]	0.3 [2.7]	0.6 [5.3]
NHL1D-16	100 [22.5]	0.8 [7.1]	0.8 [7.1]	1.6 [14.2]
NHL1D-20	160 [36.0]	1.4 [12.4]	1.4 [12.4]	2.8 [24.8]
NHL1D-25	280 [62.9]	2.4 [21.2]	2.4 [21.2]	4.8 [42.5]

Remark: l is the distance from the main body end to the gripping point.

Gripping

- When attaching fingers on the levers, design them as short and as light as possible. If the fingers are longer and heavier, the impact force when opening and closing will increase and cause a decrease in the gripping accuracy and/or wear and damage to the sliding portion. Also, to prevent the workpiece from falling down or being damaged, and to reduce the metal contact noise when gripping, plastic or rubber materials should be attached to the fingers at the parts of contact.
In cases with long grip point length or high air pressure, a large gripping moment will be exerted on the lever area that could result in damage to the lever. Always refer to the grip point limit range table, and use it within the allowed range.
- When the lever opening or closing speed is faster than necessary in relation to the workpieces, the impact force increases when opening and/or closing and causes a decrease in the gripping accuracy, and wear and damage of the sliding portion etc., therefore a speed controller should be installed and the workpiece should be gripped to make the impact as small as possible.
- When transferring the air hands in straight lines or during circular operations, use a shock absorber etc., at the travel end to stop it as smoothly as possible. Sudden stops may cause the workpieces to pop out or fall from the air hands.
- When installing the fingers on the lever, use a wrench etc., to hold it so that the lever doesn't get twisted. Tighten the mounting screws to the tightening torques shown in the table below.

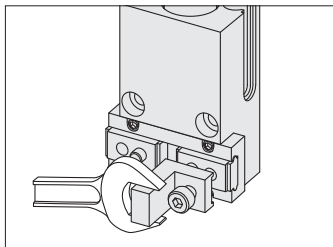

Model	Screw	Maximum tightening torque N·m [in·lbf]
NHL1D-8	M2 × 0.4	0.15 [1.33]
NHL1D-10	M3 × 0.5	0.6 [5.3]
NHL1D-16	M4 × 0.7	1.4 [12.4]
NHL1D-20	M5 × 0.8	2.9 [25.7]
NHL1D-25	M6 × 1	4.8 [42.5]

Caution: Avoid applications in which side loads are applied to the lever and lever mounting portion.

Workpiece

- Set the mass of the workpiece actually gripped to about 1/10 ~ 1/20 of the effective gripping force.
- Set the workpiece mass to about 1/30 ~ 1/50 of the effective gripping force when you move the air hands while holding the workpiece.
- As the workpiece mass which can be gripped changes greatly depending on the material and shape of the fingers, the condition of the gripping surface and the moving speed of the workpiece, etc., the values in the specifications and graphs should be used for reference only.

Body mounting method

- Method for using body through holes.

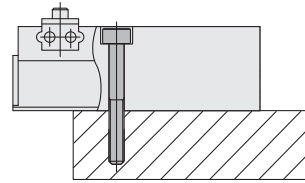

Model	Screw	Maximum tightening torque N·m [in·lbf]
NHL1D-8	M3 × 0.5	0.6 [5.3]
NHL1D-10	M3 × 0.5	0.6 [5.3]
NHL1D-16	M3 × 0.5	0.6 [5.3]
NHL1D-20	M4 × 0.7	1.4 [12.4]
NHL1D-25	M5 × 0.8	2.9 [25.7]

- Method for using mounting threads on top or bottom of the body.

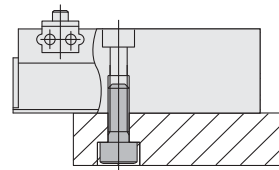

Model	Screw	Maximum tightening torque N·m [in·lbf]
NHL1D-8	M4 × 0.7	1.4 [12.4]
NHL1D-10	M4 × 0.7	1.4 [12.4]
NHL1D-16	M4 × 0.7	1.4 [12.4]
NHL1D-20	M5 × 0.8	2.9 [25.7]
NHL1D-25	M6 × 1	4.8 [42.5]

L HANDS SERIES

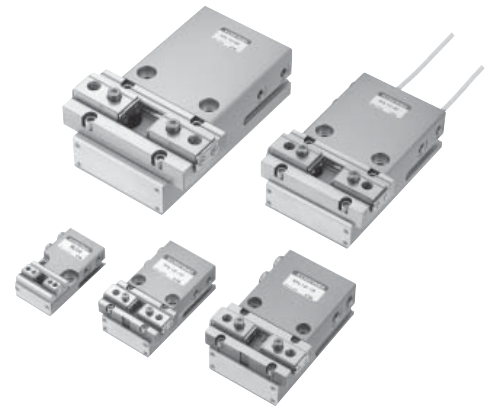

Symbol

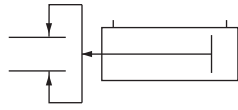

Specifications

Item	Basic model	NHL1D-8	NHL1D-10	NHL1D-16	NHL1D-20	NHL1D-25
Cylinder bore size	mm [in.]	8 [0.315]	10 [0.394]	16 [0.630]	20 [0.787]	25 [0.984]
Operation type		Double acting type				
Media		Air				
Operating pressure range	MPa [psi.]	0.25 ~ 0.7 [36 ~ 102]		0.2 ~ 0.7 [29 ~ 102]		
Proof pressure	MPa [psi.]	1.05 [152]				
Operating temperature range	°C [°F]	0 ~ 60 [32 ~ 140]				
Maximum operating frequency	cycle/min	120				
Lubrication		Not required				
Effective gripping force (F) ^{Note 1}	Closed side	11 [2.5]	21 [4.7]	50 [11.2]	85 [19.1]	165 [37.1]
	Open side	6 [1.3]	12 [2.7]	34 [7.6]	68 [15.3]	118 [26.5]
Lever open/closed stroke	mm [in.]	4 [0.157]		6 [0.236]	10 [0.394]	14 [0.551]
Repeatability ^{Note 2,3}	mm [in.]	± 0.05 [± 0.0020]				
Port size		M3 × 0.5			M5 × 0.8	
Mass	g [oz.]	25 [0.88]	65 [2.29]	140 [4.94]	290 [10.23]	540 [19.05]

Notes: 1. Values are obtained when grip point length is 30 mm [1.18 in.] (25 mm [0.984 in.] only for **NHL1D-8** closed side) under operating pressure 0.5 MPa [73 psi]. For details of the effective gripping force, see the graphs on p. 6.

2. Repeatability expresses position shift from the center of a specific workpiece that has been gripped and released 10 times in succession.

3. The L-hand has a structural gap as shown at A in the inner construction diagram. As a result, the linear bearing may shift 0.05 mm [0.0020 in.] in one direction when external force is applied. Even in the shifted position, repeatability is also ± 0.05 mm [± 0.0020 in.].

Inner Construction

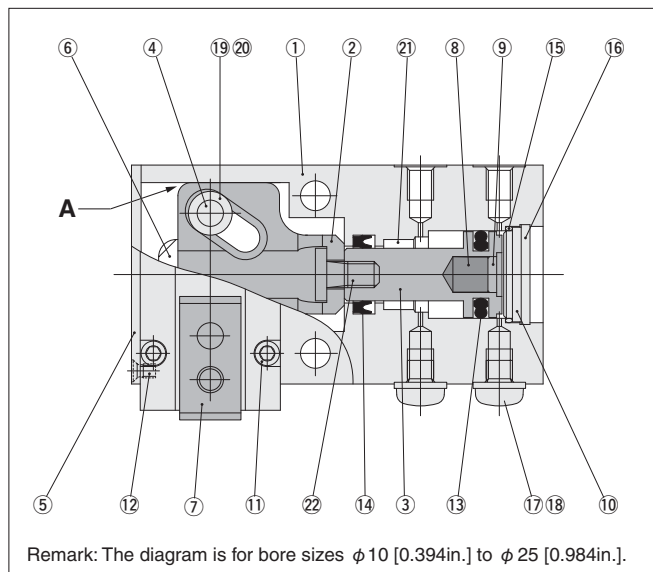

Major Parts and Materials

No.	Parts	Materials
①	Body	Aluminum alloy (hard anodized)
②	Link	Steel
③	Piston rod	Stainless steel
④	Knuckle	Stainless steel
⑤	Case	Aluminum alloy (anodized)
⑥	Plate	POM
⑦	Linear bearing	Stainless steel
⑧	Magnet	Plastic magnet
⑨	Holding cover	Aluminum alloy (anodized)
⑩	Head cover	Aluminum alloy (anodized)
⑪	Hexagon socket head screw	Stainless steel
⑫	Cross recessed countersunk head screw	Stainless steel
⑬	Piston seal	Synthetic rubber (NBR)
⑭	Rod seal	Synthetic rubber (NBR)
⑮	O-ring	Synthetic rubber (NBR)
⑯	Internal snap ring	Steel (nickel plated)
⑰	Cross recessed round head screw	Stainless steel
⑱	Gasket	Steel plate and synthetic rubber (NBR)
⑲	Ring	Steel
⑳	Plastic ring	POM
㉑	Bushing	Oil impregnated bronze
㉒	Low head screw	Stainless steel

Order Codes

NHL1 D - [] - [] [] []

Number of sensor switches
 1: With one sensor switch
 2: With two sensor switches

Bore size
 8 : ϕ 8 mm [0.315 in.]
 10 : ϕ 10 mm [0.394 in.]
 16 : ϕ 16 mm [0.630 in.]
 20 : ϕ 20 mm [0.787 in.]
 25 : ϕ 25 mm [0.984 in.]

Lead wire length
 A : 1000 mm [39 in.]
 B : 3000 mm [118 in.]
 G^{Note}: 300 mm [118 in.] with M8 connector (Note: G can be selected for ZE175 and ZE275 only)

Sensor switch
 Blank : No sensor switch
 ZE135 : 2-lead wire solid state type
 ZE235 : 2-lead wire solid state type
 ZE155 : 3-lead wire solid state type NPN output
 ZE255 : 3-lead wire solid state type NPN output
 ZE175 : 3-lead wire solid state type PNP output
 ZE275 : 3-lead wire solid state type PNP output

Operation type
 D : Double acting type

Air hands
 L Hands Series

Horizontal lead wire DC10 ~ 28V
 Vertical lead wire DC10 ~ 28V
 Horizontal lead wire DC4.5 ~ 28V
 Vertical lead wire DC4.5 ~ 28V
 Horizontal lead wire DC4.5 ~ 28V
 Vertical lead wire DC4.5 ~ 28V

● For details of sensor switches, see p.12.

Dimensions mm [in.]

NHL1D-8

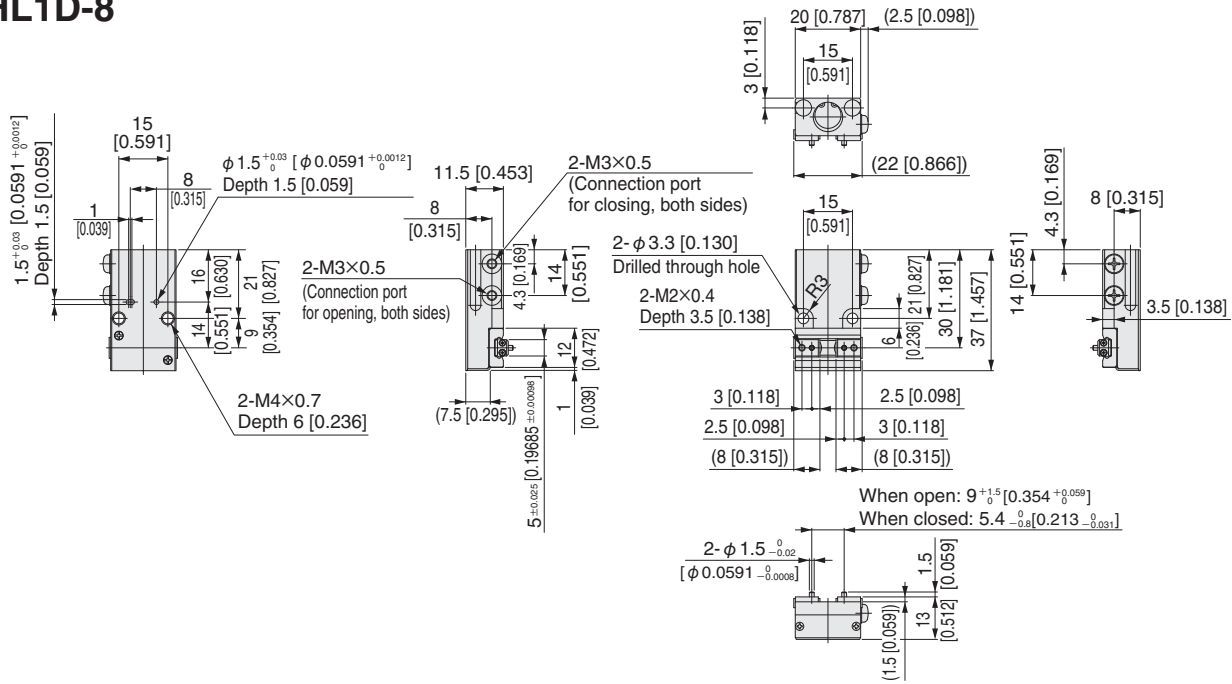

NHL1D-10

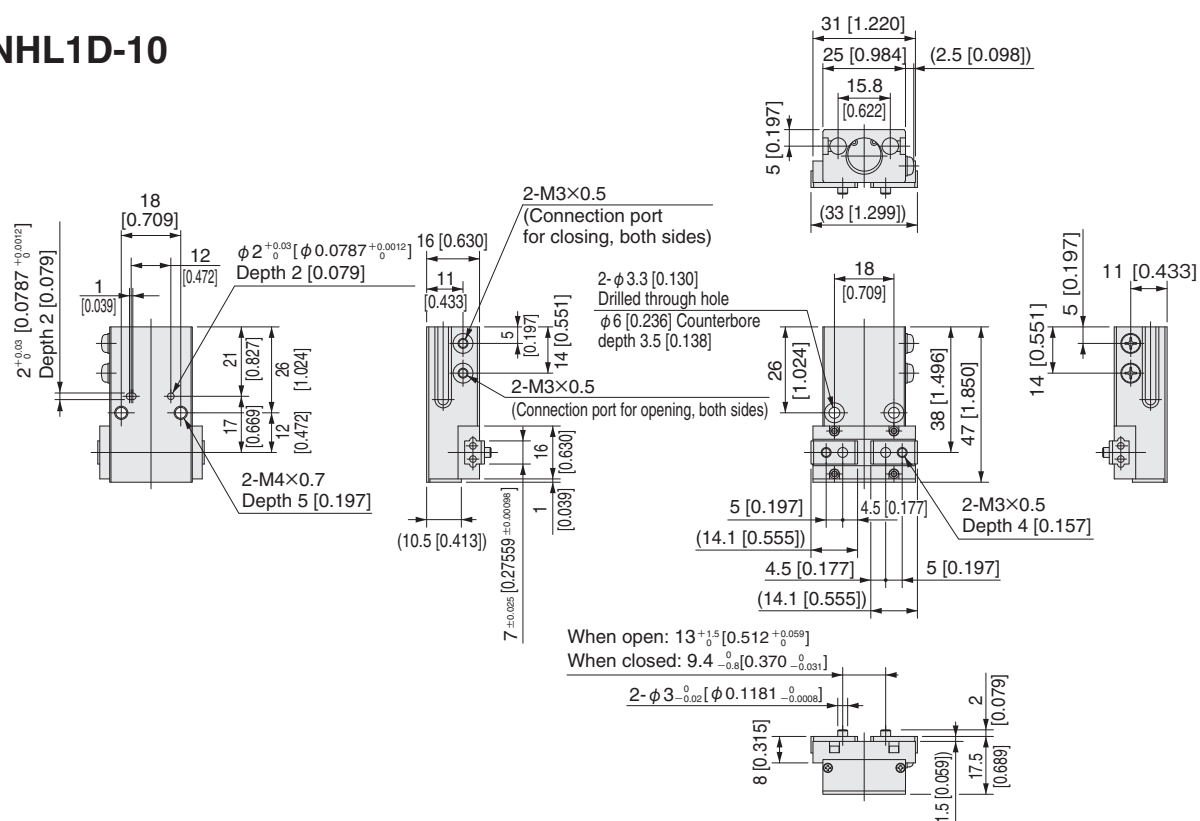

NHL1D-16

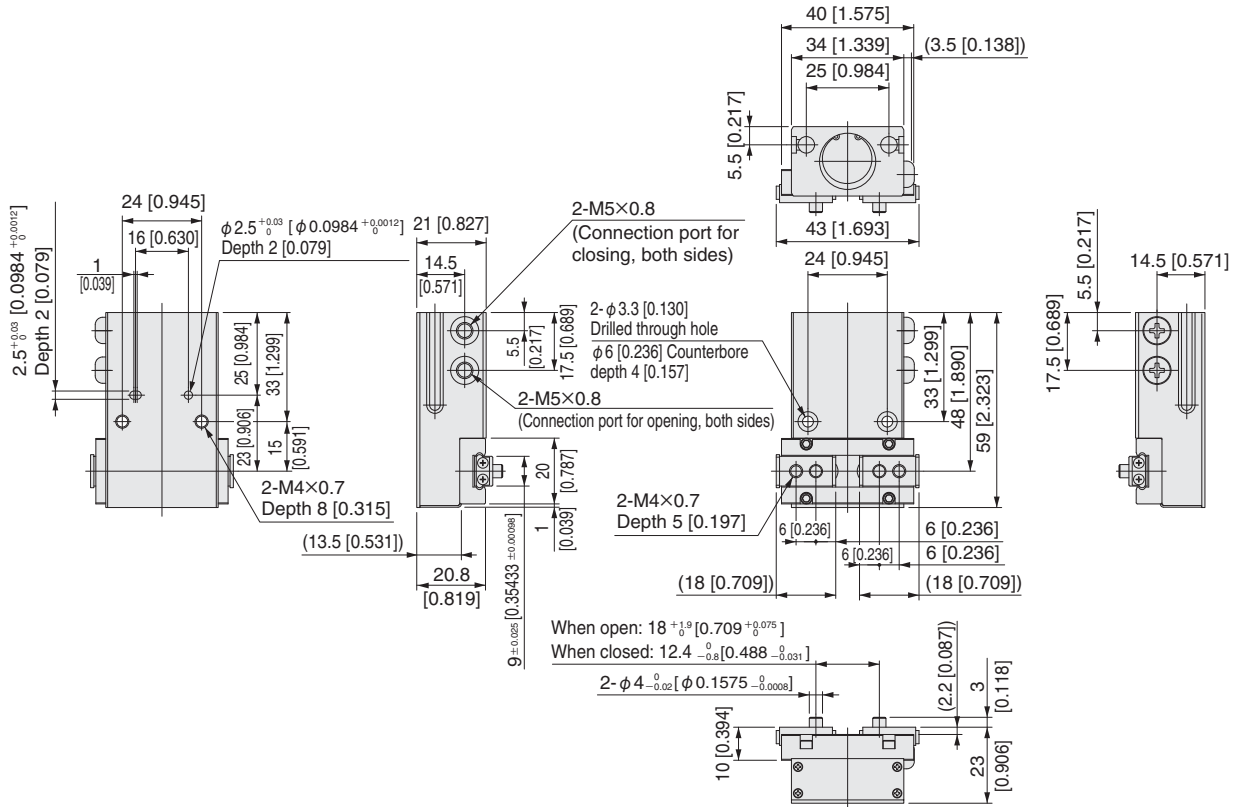

NHL1D-20

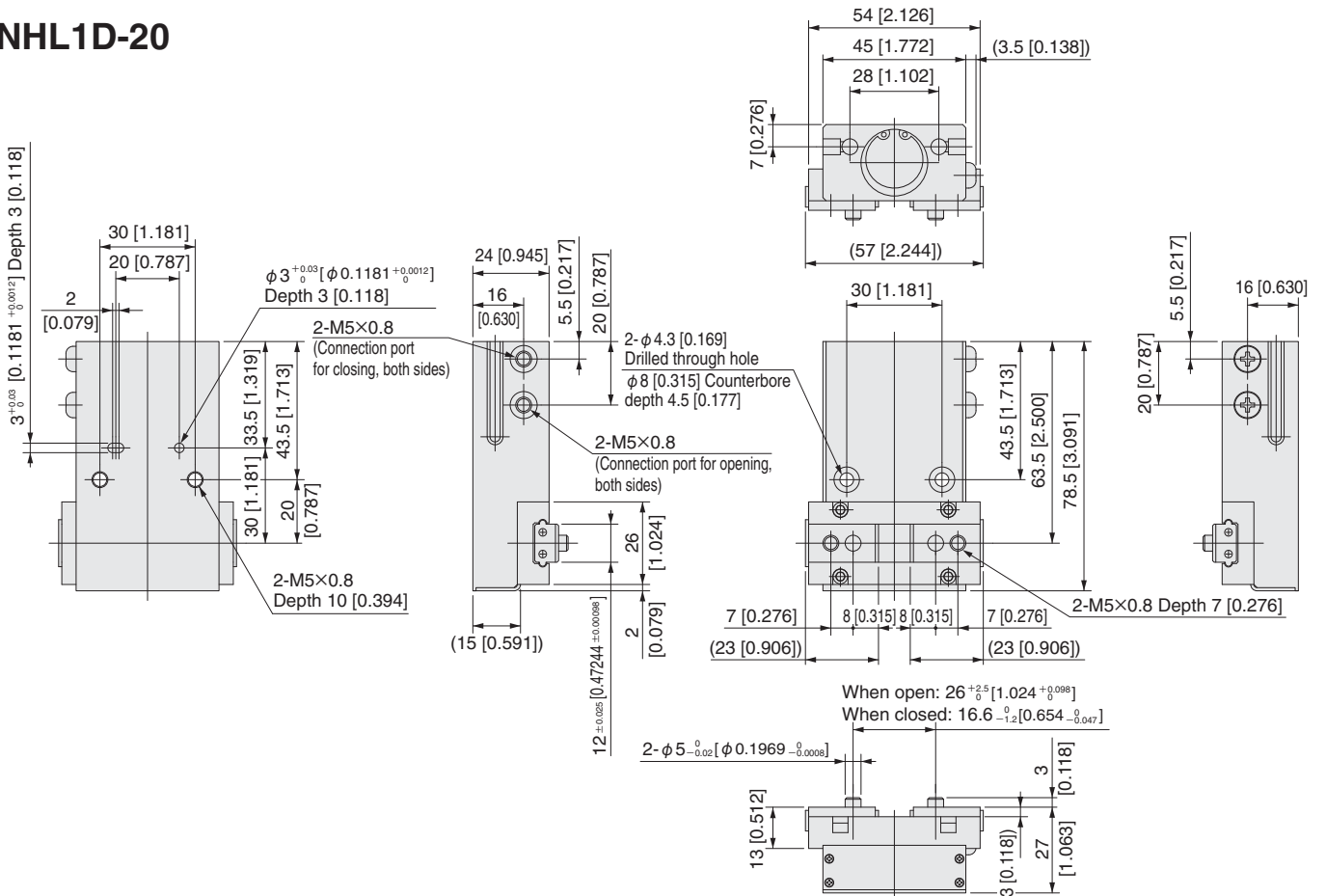

NHL1D-25

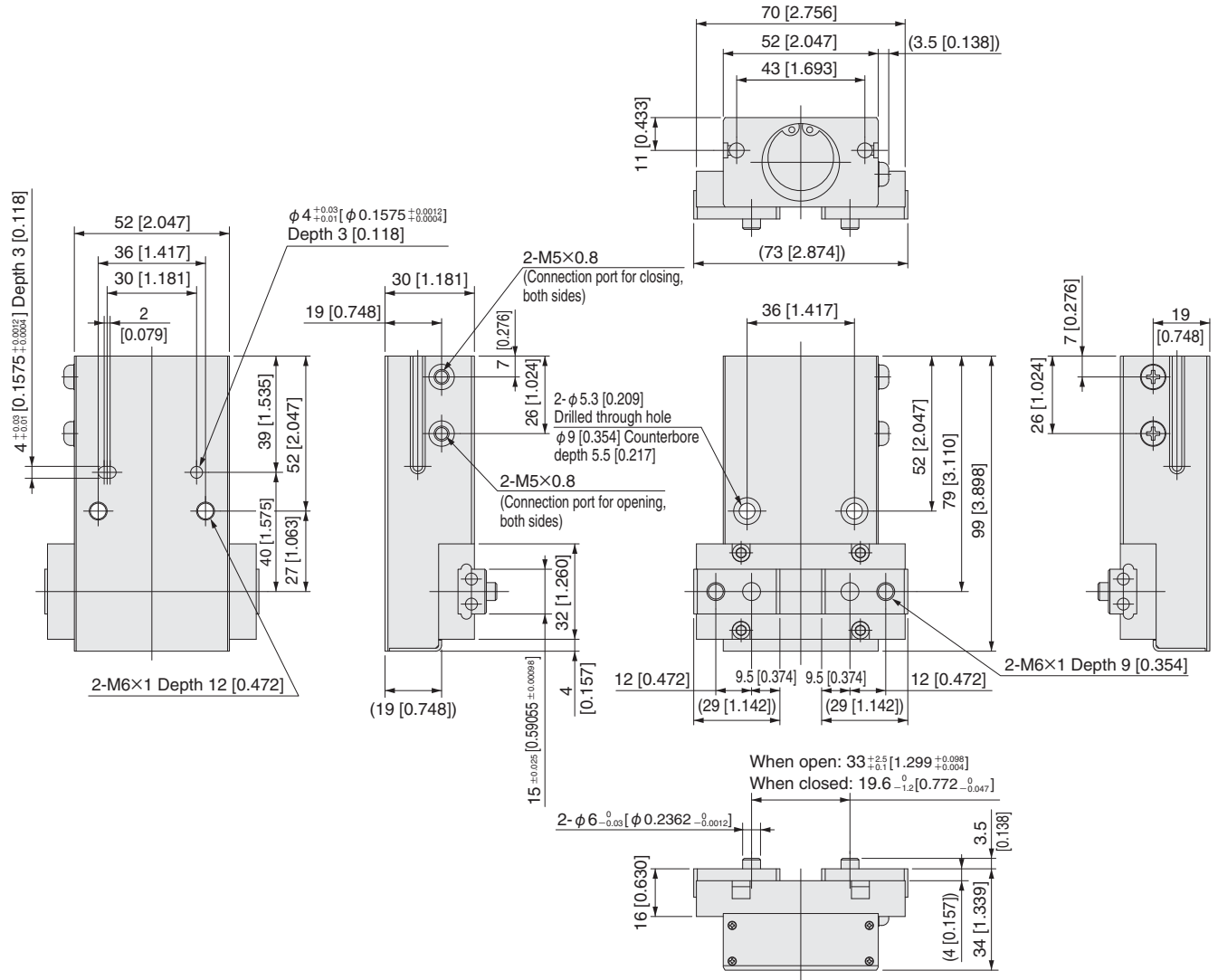

SENSOR SWITCHES

Solid State Type

Symbol

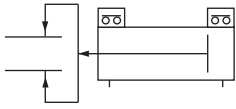

Order Codes

● Sensor switches only

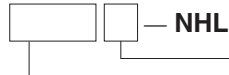

Sensor switch

- ZE135** — Solid state type 2-lead wire with indicator lamp DC10~28V Horizontal lead wire
- ZE235** — Solid state type 2-lead wire with indicator lamp DC10~28V Vertical lead wire
- ZE155** — Solid state type 3-lead wire NPN output type with indicator lamp DC4.5~28V Horizontal lead wire
- ZE255** — Solid state type 3-lead wire NPN output type with indicator lamp DC4.5~28V Vertical lead wire
- ZE175** — Solid state type 3-lead wire PNP output type with indicator lamp DC4.5~28V Horizontal lead wire
- ZE275** — Solid state type 3-lead wire PNP output type with indicator lamp DC4.5~28V Vertical lead wire

Lead wire length

- A** — 1000 mm [39 in.]
- B** — 3000 mm [118 in.]
- G** — 300 mm [11.8 in.] with M8 connector (only for **ZE175** and **ZE275**)

Specifications

● Solid state type

Item	Model	ZE135□	ZE155□	ZE235□	ZE255□	ZE175□	ZE275□
Wiring type		2-lead wire	3-lead wire NPN output	2-lead wire	3-lead wire NPN output	3-lead wire PNP output	
Lead wire direction		Horizontal		Vertical		Horizontal	Vertical
Power supply voltage		—	DC4.5~28V	—	—	DC4.5~28V	
Load voltage		DC10~28V	DC4.5~28V	DC10~28V	—	DC4.5~28V	
Load current		4~20 mA (at 25°C [77°F], 10 mA at 60°C [140°F])	50 mA MAX.	4~20 mA (at 25°C [77°F], 10 mA at 60°C [140°F])	—	50 mA MAX.	
Consumption current		—	8 mA MAX. (DC24V)	—	8 mA MAX. (DC24V)	10 mA MAX. (DC24V)	
Internal voltage drop ^{Note 1}		4V MAX.	0.5V MAX. (10V or less at 20mA)	4V MAX.	0.5V MAX. (10V or less at 20 mA)	0.5V MAX. (10V or less at 20 mA)	
Leakage current		0.7 mA MAX. (DC24V, 25°C [77°F])	50 μA MAX. (DC24V)	0.7 mA MAX. (DC24V, 25°C [77°F])	50 μA MAX. (DC24V)	50 μA MAX. (DC24V)	
Response time		1ms MAX.					
Insulation resistance		100 MΩ MIN. (at DC500V Megger, between case and lead wire terminal)					
Dielectric strength		AC500V (50/60 Hz) in 1 minute (between case and lead wire terminal)					
Shock resistance ^{Note 2}		294.2 m/s ² [30 G] (non-repeated shock)					
Vibration resistance ^{Note 2}		Total amplitude 1.5 mm [0.059 in.], 10~55 Hz {88.3m/s ² [9 G]}					
Environmental protection		IEC IP67, JIS C0920 (water-proof type)					
Operating indicator		When ON: Red LED indicator lights up					
Lead wire ^{Note 3}		PCCV 0.2SQ×2-lead (brown and blue) × ℓ	PCCV 0.15SQ×3-lead (brown, blue, and black) × ℓ	PCCV 0.2SQ×2-lead (brown and blue) × ℓ	PCCV 0.15SQ×3-lead (brown, blue, and black) × ℓ		
Ambient temperature		0~60°C [32~140°F]					
Storage temperature range		- 10~70°C [14~158°F]					
Mass		15 g [0.53 oz.] (for lead wire length A: 1000 mm [39 in.]), 35 g [1.23 oz.] (for lead wire length B: 3000 mm [118 in.]), 15 g [0.53 oz.] (for lead wire length G: 300 mm [11.8 in.] with M8 connector)					

Notes: 1. The internal voltage drop depends on load current.

2. Measured by Koganei test standard.

3. Lead wire length ℓ : A; 1000 mm [39 in.], B; 3000 mm [118 in.], G; 300 mm [11.8 in.] with M8 connector, only for **ZE175**□, **ZE275**□.

Internal Circuit

● Solid state type

● ZE135□, ZE235□

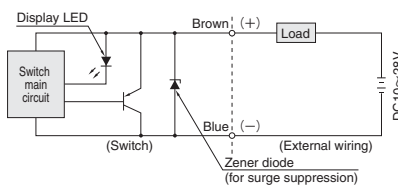

● ZE155□, ZE255□

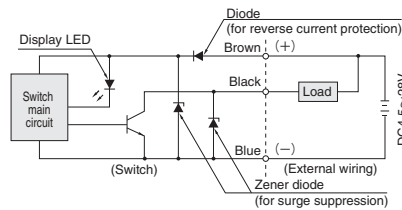

● ZE175□, ZE275□

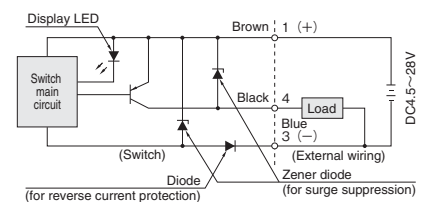

Dimensions of Sensor Switches mm [in.]

● Horizontal lead wire

● Solid state type (ZE135□, ZE155□, ZE175□)

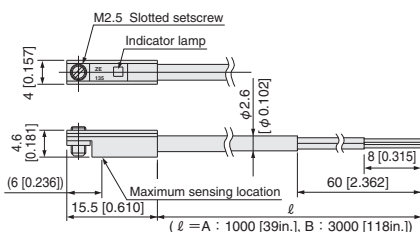

● Solid state type (ZE175G)

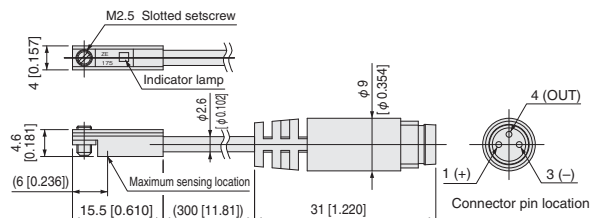

Dimensions of Sensor Switches mm [in.]

● Vertical lead wire

● Solid state type (ZE235□, ZE255□, ZE275□)

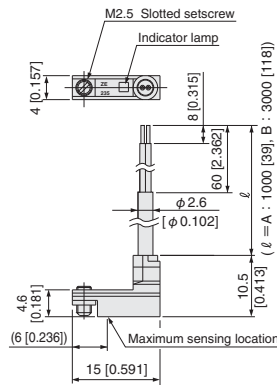

● Solid state type (ZE275G)

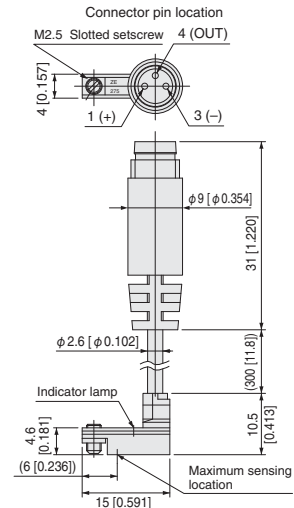

Points of Wiring Solid State Type Sensor Switches

● 2-lead wire type

● Basic connection

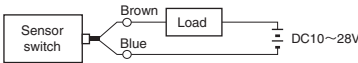

● Connection with relays

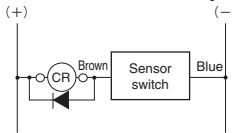

AND (series) connection and OR (parallel) connection

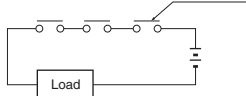
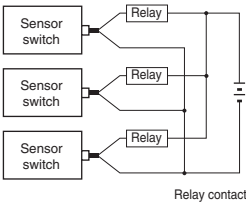

● Connection with solenoid valve

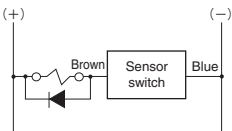

● Connection with programmable controller

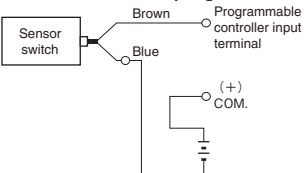

● 3-lead wire NPN output type

● Basic connection

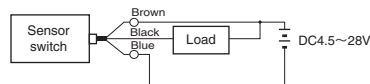

● Connection with relays

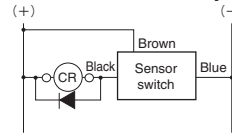

AND (series) connection and OR (parallel) connection

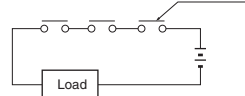
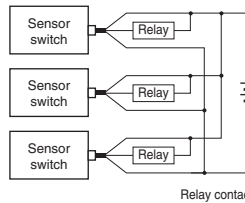

● Connection with solenoid valve

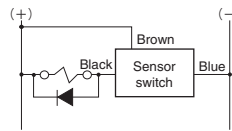

● Connection with programmable controller

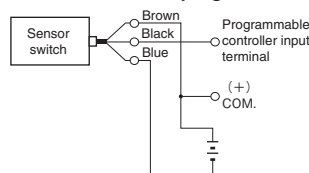

● 3-lead wire PNP output type

● Basic connection

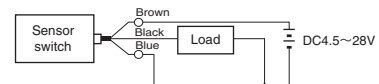

● Connection with relays

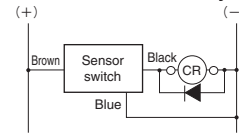

AND (series) connection and OR (parallel) connection

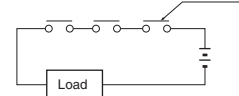
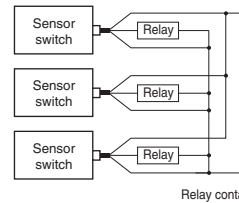

● Connection with solenoid valve

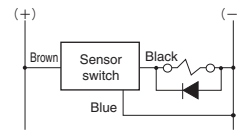

● Connection with programmable controller

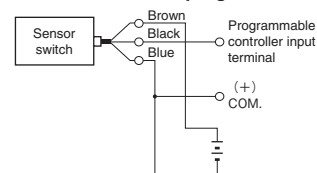

- Cautions:**
1. Connect wires according to the color of the lead wires. If the connection is incorrect, it could cause damage to the sensor switch due to the absence of an over current protection.
 2. A surge suppression protection diode is recommended for the inductive load of electromagnetic relays, etc.
 3. Avoid series (AND) connection because the voltage of the circuit will drop in proportion to the number of sensor switches.
 4. When using parallel (OR) connection, the same sensor output lines (e.g. the same black lead wires) can be connected together, but the current leakage will increase by the number of sensor switches. Therefore, be aware of load return failures.

5. Because the sensor switches are a magnetically sensitive type, avoid using them in locations subject to strong external magnetic fields or bringing them too close to power lines or to where other large electric currents are present. In addition, do not use magnetic material for the mounting bracket, because it will cause erratic operations.
6. Do not pull or bend the lead wires excessively.
7. Avoid using sensor switches in chemical or gas environments.
8. Consult us for use in ambient atmospheres subject to water or oil.

Sensor Switch Operating Range and Response Differential

● Open/closed stroke differential (Open/closed angle differential)

The stroke differential between the point where the lever on one side moves and turns the switch ON and the point where the switch is turned OFF as the lever travels in the opposite direction.

● Operating position repeatability on switching

When the lever on one side moves in the same direction, operating position repeatability is defined as the range of the deviation of the position where the switch is turned ON or turned OFF.

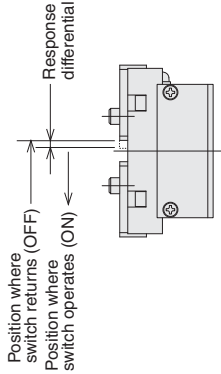

Model	Open/closed stroke differential	mm [in.]	
		Operating position repeatability (at OFF)	Operating position repeatability (at ON)
NHC1D-8	0.2 [0.008]	0.1 [0.004]	0.1 [0.004]
NHC1D-10	0.2 [0.008]	0.1 [0.004]	0.1 [0.004]
NHC1D-16	0.2 [0.008]	0.1 [0.004]	0.1 [0.004]
NHC1D-20	0.25 [0.0098]	0.1 [0.004]	0.1 [0.004]
NHC1D-25	0.25 [0.0098]	0.1 [0.004]	0.1 [0.004]

Remark: The above table shows reference values.

Length of Sensor Switch Allowed to Protrude

The maximum length that the sensor switch protrudes from the body end surface (when the levers are completely closed) is as shown in the table below. Use these values for mounting the sensor.

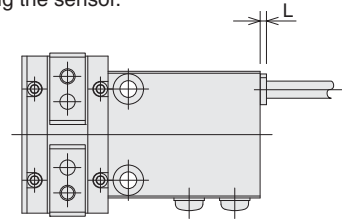

Model	mm [in.]	
	Length of sensor switch allowed to protrude L	
NHC1D-8	4 [0.157]	
NHC1D-10	2 [0.079]	
NHC1D-16	4 [0.157]	
NHC1D-20	4 [0.157]	
NHC1D-25	4 [0.157]	

Precautions for Sensor Switch Mounting

Tighten the mounting screw after the sensor switch is inserted in the switch mounting groove in the direction of the arrow in the diagram and move to the proper location. Tightening torque of the mounting screw is 0.2N·m [1.8in·lbf].

Caution: Care must be exercised that the sensor switch cannot be inserted into the switch mounting groove from the illustration's top direction.

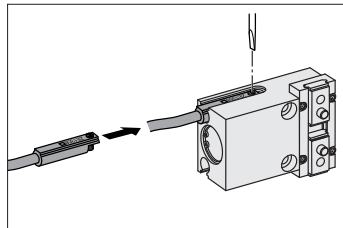

Caution: A vertical wire type sensor switch cannot reach the maximum sensing location when it is mounted as shown to the right. Be sure to insert it with the lead wire facing as shown to the left in the illustration.

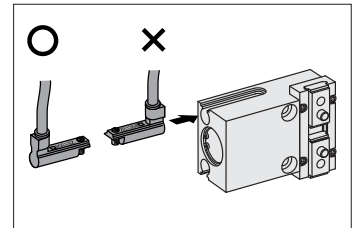

● Adjusting Sensor Switch Mounting Location (Mount the sensor switch so that the surface showing the model marking faces up.)

《For inside gripping》

- 1) Confirm the levers are completely open.

- 2) Push the switch into the groove on the body in the direction of the arrow.

- 3) By moving the switch in the direction of the arrow, the lamp turns ON.

- 4) Secure the sensor switch by the mounting screw after moving it about 0.3 mm [0.012 in.] further in the direction of the arrow from where the lamp turned ON in 3).

1) Confirm workpiece is inside gripped one.

《For outside gripping》

- 1) Confirm the levers are completely closed.

- 2) Push the switch into the groove on the body in the direction of the arrow.

- 3) By moving the sensor switch in the direction of the arrow, the lamp turns ON, and by moving it further, the lamp turns OFF. (For only NHL1D-8, the sensor switch's lamp stays ON and does not turn OFF, while the levers are closed to opening within 1 mm [0.039 in.] in outside gripping. Secure the sensor switch at this position with the switch setscrew.)

- 4) By moving back the sensor switch in the direction of the arrow (opposite direction), the lamp turns ON, and it should be secured by the sensor switch setscrew after moving it about 0.3 mm [0.012 in.] further.

1) Confirm workpiece is outside gripped one.

Remark: 1) shows the desired location where you want to confirm the switch turns ON. Install and adjust it in accordance with steps 1) ~ 4) above.

Limited Warranty

KOGANEI CORP. warrants its products to be free from defects in material and workmanship subject to the following provisions.

Warranty Period The warranty period is 180 days from the date of delivery.

Koganei Responsibility If a defect in material or workmanship is found during the warranty period, KOGANEI CORP. will replace any part proved defective under normal use free of charge and will provide the service necessary to replace such a part.

Limitations

- This warranty is in lieu of all other warranties, expressed or implied, and is limited to the original cost of the product and shall not include any transportation fee, the cost of installation or any liability for direct, indirect or consequential damage or delay resulting from the defects.

- KOGANEI CORP. shall in no way be liable or responsible for injuries or damage to persons or property arising out of the use or operation of the manufacturer's product.

- This warranty shall be void if the engineered safety devices are removed, made inoperative or not periodically checked for proper functioning.

- Any operation beyond the rated capacity, any improper use or application, or any improper installation of the product, or any substitution upon it with parts not furnished or approved by KOGANEI CORP., shall void this warranty.

- This warranty covers only such items supplied by KOGANEI CORP. The products of other manufacturers are covered only by such warranties made by those original manufacturers, even though such items may have been included as the components.

The specifications are subject to change without notice.

ISO9001
ISO14001



- ISO 9001 certified offices are Main Office, Tokyo Plant, Komagane Plant, and Sales Offices.

- ISO 14001 certified offices are Main Office, Tokyo Plant, and Komagane Plant.

URL <http://www.koganei.co.jp>

E-mail: overseas@koganei.co.jp



KOGANEI CORPORATION

OVERSEAS DEPARTMENT

3-11-28, Midori-cho, Koganei City, Tokyo 184-8533, Japan
Tel: 042-383-7271 Fax: 042-383-7276

SHANGHAI KOGANEI INTERNATIONAL TRADING CORPORATION

Room 2606-2607, Tongda Venture Building No.1, Lane 600, Tianshan Road, Shanghai, 200051, China
Tel: 021-6145-7313 Fax: 021-6145-7323

KOGANEI-PORNCHAI CO., LTD.

89/174 Moo 3, Vibhavadee Rangsit Road, Talad Bangkhen, Laksi, Bangkok, 10210, Thailand
Tel: 02-551-4025 Fax: 02-551-4015