



CAD drawing data catalog is available.



KOGANEI

ACCESSORIES GENERAL CATALOG

AIR TREATMENT, AUXILIARY, VACUUM,
AND FLUORORESIN PRODUCTS

SHOCK ABSORBERS CONTENTS

Series Introduction	565
Handling Instructions and Precautions	568
Linear Orifice Type	
KSHJ Series	
Specifications	571
Selection Guideline	572
Order Codes	574
Inner Construction, Major Parts and Materials	576
Dimensions	577
KSHA Series	
Specifications	579
Selection Guideline	580
Order Codes	581
Inner Construction, Major Parts and Materials	582
Dimensions	583
KSHC Series (Clean Room Specification)	
Specifications	585
Selection Guideline	586
Order Codes	587
Inner Construction, Major Parts and Materials	588
Dimensions	589
Evaluation of Cleanliness	591
Adjustable Absorption Capacity Type	
KSHE, KSH Series	
Specifications, Order Codes, Inner Construction and Major Parts	592
Selection Guideline	593
Dimensions	594
Shock Absorbers with Sensor Switch	
KSHES Series	
Specifications, Order Codes	595
Inner Construction and Major Parts, Dimensions	596
Optional Shock Absorbers for Particular Products	597



Caution

Before use, be sure to read the "Safety Precautions" on p. 49.

SHOCK ABSORBER Series

Fixed Absorption Capacity Linear Orifice Type

KSHJ Series

Page 571

Total of 12 sizes and 66 models from M4 to M27 size.

Offers wide range of speeds, with maximum impact speed of 0.8 m/s to 3 m/s^{Note}.

Note: The maximum impact speed varies by model.
See specification table on p.571.



● With cap



● With stopper nut



● With side mounting bracket



What is the linear orifice type?

Use of a linear orifice mechanism, in which the orifice changes linearly, ensures smooth shock absorption.

Achieves the performance of shock absorbers with next-size-up stroke lengths, to reduce vibrations on mounting frames and equipment.

Reduces the shock value in impacts, to lower the noise during workpiece impacts.

Operation principle

The piston stroke linearly squeezes the oil path, for soft absorption of shocks.

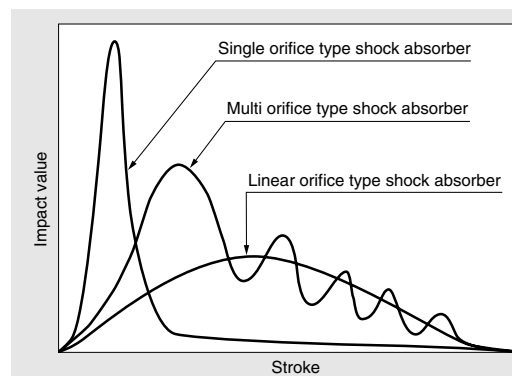
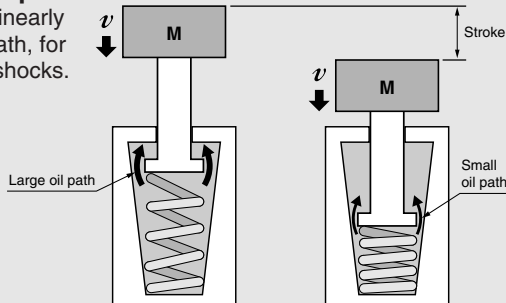

Fixed Absorption Capacity Linear Orifice Type

KSHA Series

Page 579

Total of five sizes, from M6 to M14.

All sizes can be set with heavy load and light load absorption capacities.



● Insert mounting type



● With cap



● With stopper nut



● With flange mounting bracket



● With side mounting bracket



KSHC Series (Clean Room Specification) Class 5 (Equivalent to FED-STD209E Class 100) compatibility

Page 585

Total of eight sizes, from M6 to M25.

Uses a special particle pocket structure, to prevent flying dust out.



● With cap

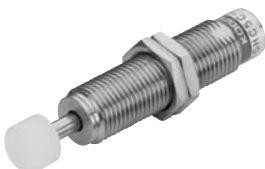

● With stopper nut



Adjustable Absorption Capacity Type

KSHE Series	KSHES Series
<p data-bbox="124 185 879 241"> Multi orifice type Self-compensating type shock absorber. Optimum for high-speed impacts. </p> <div data-bbox="236 300 863 448"> <p data-bbox="148 450 863 472"> Side mounting bracket : -2 Flange mounting bracket : -3 Stopper nut : -S </p> </div> <div data-bbox="236 566 802 949"> <p data-bbox="240 837 384 860">KSHE 10×20C</p> <p data-bbox="523 927 639 949">KSHE12×22</p> </div>	<p data-bbox="959 185 1481 275"> Multi orifice type with sensor switches Can perform position detection simultaneously with completion of shock absorption. </p> <div data-bbox="1034 255 1433 613"> <p data-bbox="1007 647 1203 669">KSHES12×22-H-□□</p> </div> <div data-bbox="1066 600 1433 981"> <p data-bbox="1107 958 1315 981">KSHES12×22-HS-□□</p> </div>
KSH Series	Page 592
<p data-bbox="124 1088 456 1144"> Single orifice type Optimum for low-speed impacts. </p> <div data-bbox="539 1126 1161 1361"> <p data-bbox="555 1346 660 1368">KSH8×10C</p> <p data-bbox="986 1346 1091 1368">KSH12×22</p> </div>	

Safety Precautions (Shock Absorbers)

The following is a safety precaution to Shock Absorbers. For other safety precautions, be sure to read the precautions on p.49.

Danger

- Do not touch or approach too close to the product while it is in operation. Also, do not attempt to mount a shock absorber or adjust operations while devices are operating. Unintended movement of devices could result in personal injury.

Warning

- Never loosen or remove the small screw on the rear end surface of the shock absorber. The oil inside will leak out and damage shock absorber function, which could result in injury.
- For product mounting, always observe the handling instructions and precautions. In addition, when a product has been mounted, before starting operation always check whether mounting nuts have been attached and are secured, etc. Looseness in the mounting nuts could lead to equipment damage, or to accidents.

Caution

- Do not coat the sliding sections with any lubricant whatsoever. Such lubrication could alter or degrade the properties of the product materials, or reduce performance.
- Attempting to use the shock absorber with cap over the specification range could result in damage to the cap or to its flying off and causing personal injury. Moreover, if cracks or fractures appear in the cap, replace it as quickly as possible.

Attention

- When the product's service life is completed or when it is no longer needed, dispose of it as an industrial waste product, in accordance with the Waste Disposal and Public Cleaning Law, or with other local laws and ordinances. Note that because the special oil used in the KSHC series (clean room specification) gives off hydrofluoric acid, a corrosive, toxic substance, when incinerated, disposal should be performed at an incinerator equipped with acid-resisting toxic removal facilities. If large volumes need disposal, consign the operation to a registered waste disposal company.
- The maximum absorption performance in the specifications are values at normal temperatures (20~25°C [68~77°F]). Be aware that performance and characteristics may change depending on the operating temperature.
- The shock absorber's absorption capacity can change depending on the impact speed. Use it within the range shown in the selection graphs (impact mass and impact speed graphs) on p.572, 580, 586 and 593.

Handling Instructions and Precautions



General precautions

If mounting in locations subject to dripping water, dripping oil, etc., or to large amounts of dust, use something to cover and protect the unit. Accumulations of water, oil, or dust can reduce the shock absorber's service life.



Adjustment of shock absorption capacity

● Adjustable absorption capacity type : KSHE and KSH series

1. Align the white mark on the shock absorption adjusting knob to 2 or 3 on the scale.
2. For cases where the stroke end is still undergoing shocks, turn the adjusting knob toward 6 on the scale. In cases where the rod stops before the preset stroke end, or when the shock at time of impact is very large, turn the adjusting knob toward "0" on the scale.
3. When adjustment is complete, always be sure to tighten the lock screw to secure the adjusting knob in place.
4. The KSHE series are designed so that the final orifice hole is closed at the stroke end. Shortening the stroke could lead to an inability to adequately absorb the impact energy. It is recommended that use of the full stroke be made. Moreover, the shock absorber for the KSHE series operate differently when its rod is manually pushed in as opposed to actual operation.

● Fixed absorption capacity type : KSHJ, KSHA, KSHC series

For the fixed absorption capacity type, shock absorption capacity cannot be adjusted. See the Selection Guideline on p.572, 580, 586 to select a model with the optimum shock absorption capacity.



Mounting

1. Mount the shock absorber so that the load contacts at the center of the rod, and it is not subjected to off-centered loads. An off-centered load could result in breakage or defective rod returns. If there is concern that off-centered loads will occur, install a guide, etc.
2. Two or more shock absorbers can be mounted in parallel, to boost absorption capacity. In such an arrangement, however, be careful to ensure that the load is evenly distributed to each shock absorber.
3. The surface in direct contact with the shock absorber rod should have a hardness of HRc40 or more (excluding with cap models).
4. When mounting the shock absorber, do not exceed the maximum tightening torque for the hexagon nut, shown in the table below. Excessive tightening could damage the unit.

N · m [ft · lbf]	
Model	Maximum tightening torque
KSHJ4×3 (C) -01,-02	0.5 [0.37]
KSHJ6×4 (C) -01,-02	0.85 [0.63]
KSHJ8×5 (C) -01,-11	2.5 [1.8]
KSHJ8×8 (C) -01,-02,-11,-12	2.5 [1.8]
KSHJ10×10 (C) -01,-02	6.5 [4.8]
KSHJ10×15 (C) -01,-03	6.5 [4.8]
KSHJ12×10 (C) -01,-02	6.5 [4.8]
KSHJ14×12 (C) -01,-02	12.0 [8.9]
KSHJ16×15 (C) -01,-02	20.0 [14.8]
KSHJ18×16 (C) -01,-02	25.0 [18.4]
KSHJ20×16 (C) -01,-02	30.0 [22.1]
KSHJ22×25 (C) -01,-02	35.0 [25.8]
KSHJ25×25 (C) -01,-11,-12	42.0 [31.0]
KSHJ27×25 (C) -01,-02,-11,-12	42.0 [31.0]

Handling Instructions and Precautions

N·m [ft·lbf]	
Model	Maximum tightening torque
KSHA4×4, CS-KSHC4×4	0.85 [0.63]
KSHA5×5, CS-KSHC5×5	2.5 [1.84]
KSHA6×5	6.5 [4.79]
KSHA6×8, CS-KSHC6×8	
KSHA7×8, CS-KSHC8×8	12.0 [8.85]
KSHA8×10, CS-KSHC9×10	
CS-KSHC11×15C	20.0 [14.8]
CS-KSHC14×16C	30.0 [22.1]
CS-KSHC18×25C	42.0 [31.0]

N·m [ft·lbf]	
Model	Maximum tightening torque
KSHE5×8, KSH5×8	8.0 [5.90]
KSHE6×10, KSH6×10	
KSHE(S)8×15, KSH8×10	15.0 [11.1]
KSHE(S)10×20, KSH10×15	24.0 [17.7]
KSHE(S)12×22, KSH12×22	30.0 [22.1]

● Fixed absorption capacity type KSHJ, KSHA, KSHC series

1. If using “with cap” or changing the stroke to adjust absorption capacity, use a stopper.
2. If using “with cap”, always mount a stopper nut (-S) or an external stopper to ensure that the cap is not subjected to loads at the stroke end. For the stopper nut mounting position, see the dimensions in the table below. While the shock absorber can be used without a stopper nut (-S) or external stopper, in such an arrangement, the stop position may change due to deformation of the cap after a long period of use.

mm [in.]	
Model	A
KSHJ4×3C-01,-02	3 [0.118]
KSHJ6×4C-01,-02	4 [0.157]
KSHJ8×5C-01,-11	5 [0.197]
KSHJ8×8C-01,-02,-11,-12	8 [0.315]
KSHJ10×10C-01,-02	10 [0.394]
KSHJ10×15C-01,-03	15 [0.591]
KSHJ12×10C-01,-02	10 [0.394]
KSHJ14×12C-01,-02	12 [0.472]
KSHJ16×15C-01,-02	15 [0.591]
KSHJ18×16C-01,-02	16 [0.630]
KSHJ20×16C-01,-02	16 [0.630]
KSHJ22×25C-01,-02	25 [0.984]
KSHJ25×25C-01,-11,-12	25 [0.984]
KSHJ27×25C-01,-02,-11,-12	25 [0.984]

mm [in.]	
Model	A
KSHA4×4C, CS-KSHC4×4C	3.5~3.9 [0.138~0.154]
KSHA5×5C, CS-KSHC5×5C	4.5~4.9 [0.177~0.193]
KSHA6×5C	
KSHA6×8C, CS-KSHC6×8C	7.5~7.9 [0.295~0.311]
KSHA7×8C, CS-KSHC8×8C	
KSHA8×10C, CS-KSHC9×10C	9.5~9.9 [0.374~0.390]
CS-KSHC11×15C	14.5~14.9 [0.571~0.587]
CS-KSHC14×16C	15.5~15.9 [0.610~0.626]
CS-KSHC18×25C	24.5~24.9 [0.965~0.980]

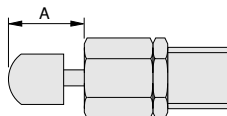

3. For swing impacts, ensure that the angle of eccentricity between the load direction and the center line of the shock absorber is at or below the specification values shown on p.571, p.579 and p.585.
4. Do not loosen or remove the small screw on the rear end of the shock absorber. The oil contained inside could leak out, damaging shock absorber functions.

● Insert mounting : KSHA□×□□-X

1. For the dimensions of the mounting hole for the insert mount, see the insert mounting hole drawings on p.583.
2. When using a panel mounting, use the values in the table below to determine the maximum thickness of the panel.

mm [in.]	
Model	Maximum panel thickness
KSHA6×8□-X	8 [0.315]
KSHA7×8□-X	10 [0.394]

● Adjustable absorption capacity type KSHE and KSH series

1. Do not use the end surface of the shock absorber body in the rod side as a stopper. Always use a stopper nut (Order code: -S) or external stopper.
2. When using the stopper nut, adjust the stopper nut location so that it protrudes 0.5 mm [0.02 in.] from the end surface of the KSHE series shock absorber body, and 0.5 to 1.0 mm [0.02 to 0.04 in.] from the KSH series.
3. When using an external stopper, mount so that impacting objects are stopped 0.5 mm [0.02 in.] in front of the end surface of the KSHE series shock absorber body, and 0.5 to 1.0 mm [0.02 to 0.04 in.] in front of the KSH series.
4. For swing impacts, ensure that the angle of eccentricity between the load direction and the center line of the shock absorber is 3° or less.

KSHES series

1. For holders that can directly stop loads, use a stopper type holder (-HS). If using holders that do not have a stopper function (-H), use an external stopper.
2. Holders and external stoppers should receive all the remaining energy for loads when stopping. Do not let the cap become subjected to loads at the stroke end.

● Calculation

For the calculations, use the speed immediately before striking the absorber. For air cylinders, the speed immediately before striking is larger than the average speed obtained from the "time required for cylinder stroke". In this case, shorter strokes increase the speed, and it reaches 1.2 to 2.0 times higher than the average speed.

Selection procedure of shock absorber

Impact mass m kg
 [Impact weight w' lbf.]
 Impact speed v m/s [ft./sec.]

When additional energy is not applied.

When additional energy from the cylinder, rotary actuator, etc., is applied

Item	Horizontal impact		Horizontal impact		Vertical impact		Swing impact			
	Simple horizontal impact		Cylinder impact	Free fall	Cylinder impact	Arm swing	Turn table			
Impact example										
Impact mass m kg [Impact weight w' lbf.]	m	w'	m	w'	m	w'	m	w'	m	w'
Impact speed v m/s [ft./sec.]	v		v		v		$v=R \cdot \omega$		$v=R \cdot \omega$	
Kinetic energy E_1 J [ft·lbf]	$\frac{m \cdot v^2}{2}$	$\left\{ \frac{w' \cdot v^2}{2 \cdot g} \right\}$	$\frac{m \cdot v^2}{2}$	$\left\{ \frac{w' \cdot v^2}{2 \cdot g} \right\}$	$m \cdot g \cdot h$	$\left\{ w' \cdot h \right\}$	$\frac{m \cdot v^2}{2}$	$\left\{ \frac{w' \cdot v^2}{2 \cdot g} \right\}$	$\frac{I \cdot \omega^2}{2}$	$\left\{ \frac{I' \cdot \omega^2}{2} \right\}$
Thrust, mass, and other additional energy E_2 J [ft·lbf]	—		$F \cdot L$	$\left\{ F' \cdot L \right\}$	$m \cdot g \cdot L$	$\left\{ w' \cdot L \right\}$	$(m \cdot g + F) \cdot L$	$\left\{ (w' + F) \cdot L \right\}$	$\frac{T \cdot L}{R}$	$\left\{ \frac{T' \cdot L}{R} \right\}$
Total energy E J [ft·lbf]	E_1		$E_1 + E_2$		$E_1 + E_2$		$E_1 + E_2$		$E_1 + E_2$	

Shaded areas show calculations using the imperial units.
 [] shows imperial units.

Maximum operating frequency cycle/min
 Operating ambient temperature °C [°F]

Select models where the m, v, E, L , operating frequency and temperature satisfy the specifications.

Remark: The shock absorber's absorption energy will vary depending on speed, temperature, and other conditions. This calculation equation is provided for a general indication only. We recommend selecting from the selection graphs on p.572~573, 580, 586, and 593.

Code explanations	(Unit)
m : Impact mass	kg
w' : Impact weight	[lbf.]
v : Impact speed	m/s [ft./sec.]
E : Total energy	J [ft·lbf]
E_1 : Kinetic energy	J [ft·lbf]
E_2 : Additional energy	J [ft·lbf]
g : Acceleration of gravity	9.8m/s ² [32.2ft./sec. ²]
F : Cylinder thrust	N
$F = \pi / 4 \times D^2 \times P$	
D : Bore size	mm
P : Operating air pressure	MPa
F : Cylinder thrust	N
F' : Cylinder thrust	[lbf.]
$F' = \pi / 4 \times D'^2 \times P'$	
D' : Bore size	[in.]
P' : Operating air pressure	[psi. = lbf./in. ²]
L : Shock absorber stroke	m [ft.]
h : Height of fall	m [ft.]
T : Torque	N·m
T' : Torque	[ft·lbf]
ω : Angular velocity (90° = 1.57rad.)	rad/s
N : Rotating speed $\omega = 2 \pi N / 60$	rpm
R : Distance from center of rotation to point of impact	m [ft.]
I : Inertia moment relating to center of gravity	kg·m ²
I' : Inertia moment relating to center of gravity	[ft·lbf·sec ²]

SHOCK ABSORBERS

LINEAR ORIFICE TYPE

KSHJ Series



Specifications

Item	Model	KSHJ4×3-01	KSHJ4×3-02	KSHJ6×4-01	KSHJ6×4-02	KSHJ8×5-01, -11
Maximum absorption	J [ft·lbf]	0.3 [0.22]	0.2 [0.15]	0.5 [0.37]	0.3 [0.22]	1 [0.7]
Absorbing stroke	mm [in.]	3 [0.12]		4 [0.16]		5 [0.20]
Maximum impact speed	m/s [ft./sec.]	0.8 [2.6]	1 [3.3]	1 [3.3]		1 [3.3]
Maximum operating frequency	cycle/min	60				
Maximum absorption per unit of time	J/min [ft·lbf/min.]	10 [7.4]		20 [14.8]		36 [26.6]
Spring return force	N [lbf.]	2 [0.4]		3 [0.7]		6 [1.3]
Angle variation		1° or less				
Operating temperature range ^{Note}	°C [°F]	0~60 [32~140]				

Item	Model	KSHJ8×8-01, -11	KSHJ8×8-02, -12	KSHJ10×10-01	KSHJ10×10-02	KSHJ10×15-01	KSHJ10×15-03
Maximum absorption	J [ft·lbf]	2 [1.5]		3 [2.2]		5 [3.7]	6.5 [4.8]
Absorbing stroke	mm [in.]	8 [0.32]		10 [0.39]		15 [0.59]	
Maximum impact speed	m/s [ft./sec.]	1 [3.3]	1.5 [4.9]	1 [3.3]	2 [6.6]	1 [3.3]	3 [9.8]
Maximum operating frequency	cycle/min	60					
Maximum absorption per unit of time	J/min [ft·lbf/min.]	60 [44]		120 [89]		200 [148]	
Spring return force	N [lbf.]	8.6 [1.93]		8 [1.8]		9.8 [2.20]	
Angle variation		1° or less					
Operating temperature range ^{Note}	°C [°F]	0~60 [32~140]					

Item	Model	KSHJ12×10-01	KSHJ12×10-02	KSHJ14×12-01	KSHJ14×12-02	KSHJ16×15-01	KSHJ16×15-02
Maximum absorption	J [ft·lbf]	6 [4.4]		10 [7.4]		15 [11.1]	
Absorbing stroke	mm [in.]	10 [0.39]		12 [0.47]		15 [0.59]	
Maximum impact speed	m/s [ft./sec.]	1 [3.3]	2 [6.6]	1 [3.3]	2 [6.6]	1 [3.3]	2 [6.6]
Maximum operating frequency	cycle/min	60		40			
Maximum absorption per unit of time	J/min [ft·lbf/min.]	220 [162]		240 [177]		280 [207]	
Spring return force	N [lbf.]	7.6 [1.71]		9.2 [2.07]		17.4 [3.91]	
Angle variation		1° or less				3° or less	
Operating temperature range ^{Note}	°C [°F]	0~60 [32~140]					

Item	Model	KSHJ18×16-01	KSHJ18×16-02	KSHJ20×16-01	KSHJ20×16-02	KSHJ22×25-01	KSHJ22×25-02
Maximum absorption	J [ft·lbf]	20 [14.8]		30 [22.1]		50 [36.9]	
Absorbing stroke	mm [in.]	16 [0.63]				25 [0.98]	
Maximum impact speed	m/s [ft./sec.]	1 [3.3]	2 [6.6]	1 [3.3]	2 [6.6]	1 [3.3]	2 [6.6]
Maximum operating frequency	cycle/min	40		30			
Maximum absorption per unit of time	J/min [ft·lbf/min.]	320 [236]		450 [332]		500 [369]	
Spring return force	N [lbf.]	22 [4.95]				28.5 [6.41]	
Angle variation		3° or less					
Operating temperature range ^{Note}	°C [°F]	0~60 [32~140]					

Item	Model	KSHJ25×25-01	KSHJ25×25-11	KSHJ25×25-12	KSHJ27×25-01,-11	KSHJ27×25-02,-12	
Maximum absorption	J [ft·lbf]	60 [44.3]					
Absorbing stroke	mm [in.]	25 [0.98]					
Maximum impact speed	m/s [ft./sec.]	1.5 [4.9]	1 [3.3]	1.5 [4.9]	1 [3.3]	1.5 [4.9]	
Maximum operating frequency	cycle/min	30					
Maximum absorption per unit of time	J/min [ft·lbf/min.]	700 [516]		800 [590]			
Spring return force	N [lbf.]	28.5 [6.41]		28.5 [6.41]			
Angle variation		3° or less					
Operating temperature range ^{Note}	°C [°F]	0~60 [32~140]					

Note: Shock absorption capacity fluctuates depending on ambient temperature or speed.

Selection Guideline

Precautions for Use of Selection Graphs

1. The selection graphs are calculated for a cylinders with air pressure of 0.5 MPa [73 psi].
2. Select a shock absorber that is close to yet within the capacity line.

Selection Graphs

● KSHJ4 × 3

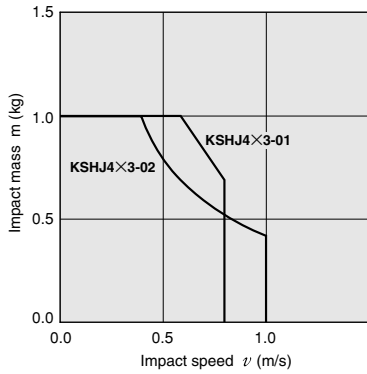

● KSHJ6 × 4

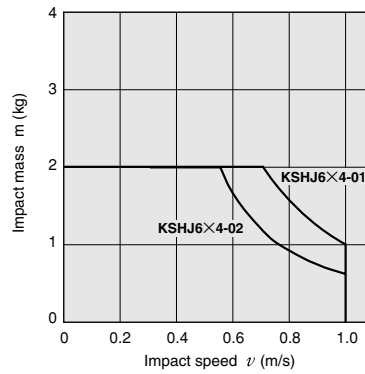

● KSHJ8 × 5

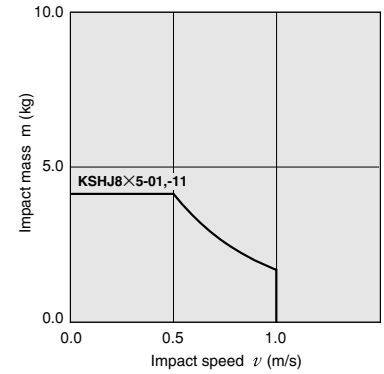

1 kg = 2.20 lb. 1 m/s = 3.28 ft./sec.

● KSHJ8 × 8

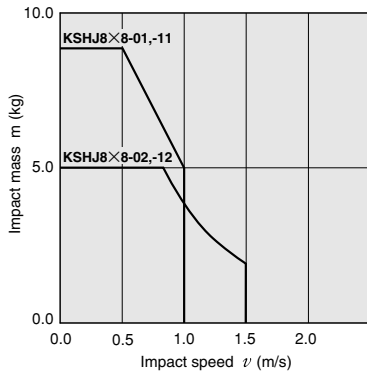

● KSHJ10 × 10

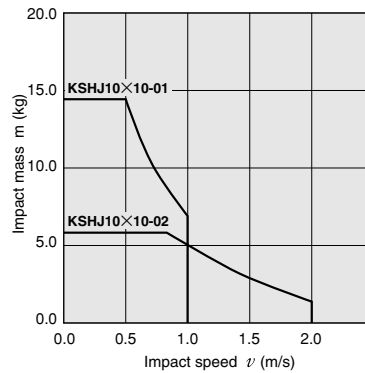

● KSHJ10 × 15

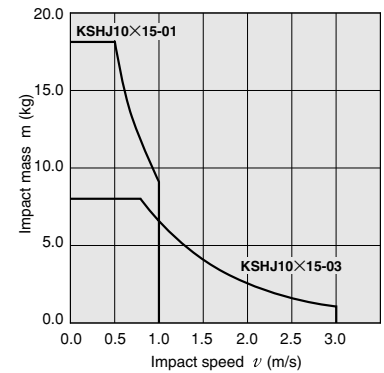

1 kg = 2.20 lb. 1 m/s = 3.28 ft./sec.

● KSHJ12 × 10

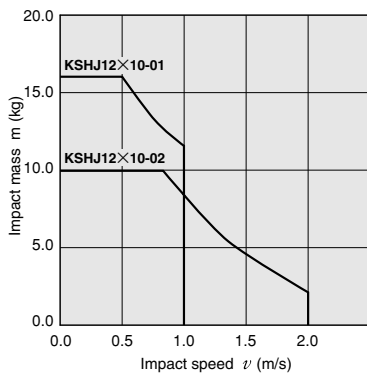

● KSHJ14 × 12

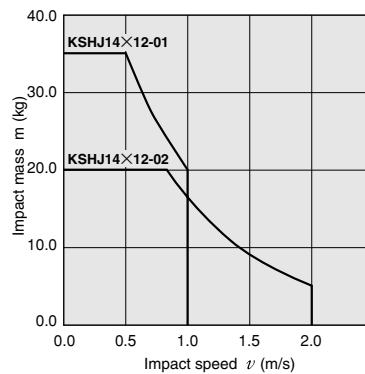

● KSHJ16 × 15

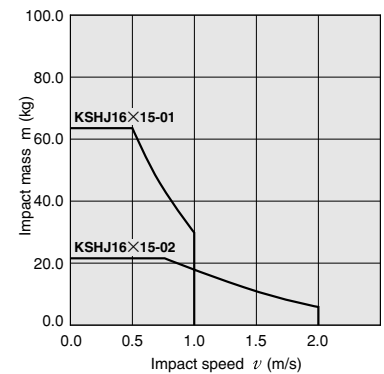

1 kg = 2.20 lb. 1 m/s = 3.28 ft./sec.

Selection Guideline

● KSHJ18 × 16

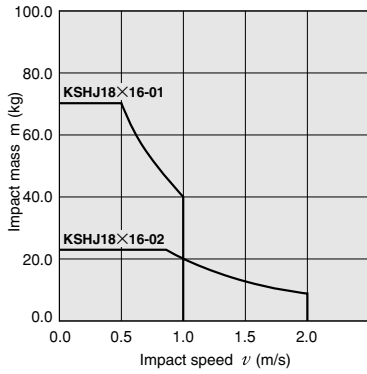

● KSHJ20 × 16

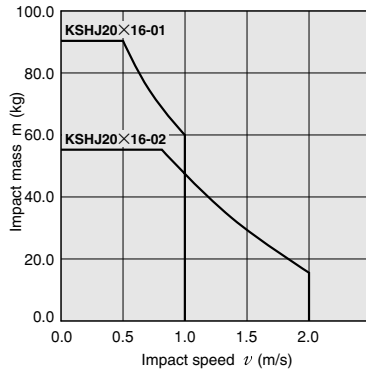

● KSHJ22 × 25

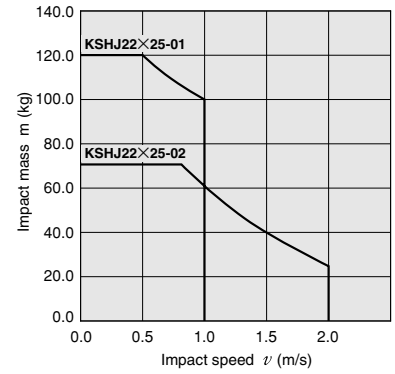

1 kg = 2.20 lb. 1 m/s = 3.28 ft./sec.

● KSHJ25 × 25

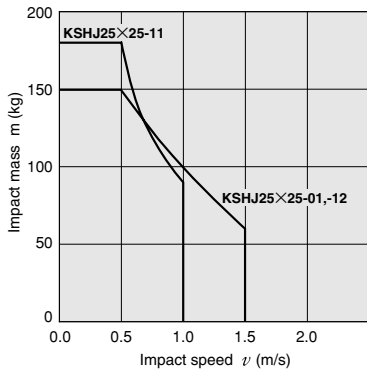

● KSHJ27 × 25

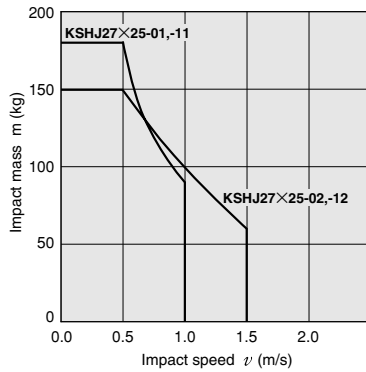

1 kg = 2.20 lb. 1 m/s = 3.28 ft./sec.

■ Recommended bore size

Model	Bore size mm [in.]												
	φ 4 [0.157]	φ 6 [0.236]	φ 8 [0.315]	φ 10 [0.394]	φ 12 [0.472]	φ 16 [0.630]	φ 20 [0.787]	φ 25 [0.984]	φ 32 [1.260]	φ 40 [1.575]	φ 50 [1.969]	φ 63 [2.480]	φ 80 [3.150]
KSHJ4 × 3	●	●	●										
KSHJ6 × 4		●	●	●									
KSHJ8 × 5			●	●	●	●							
KSHJ8 × 8			●	●	●	●							
KSHJ10 × 10				●	●	●	●						
KSHJ10 × 15				●	●	●	●						
KSHJ12 × 10					●	●	●	●					
KSHJ14 × 12						●	●	●	●				
KSHJ16 × 15							●	●	●	●			
KSHJ18 × 16								●	●	●			
KSHJ20 × 16									●	●	●		
KSHJ22 × 25										●	●	●	
KSHJ25 × 25										●	●	●	●
KSHJ27 × 25										●	●	●	●

Order Codes

● 4 × 3

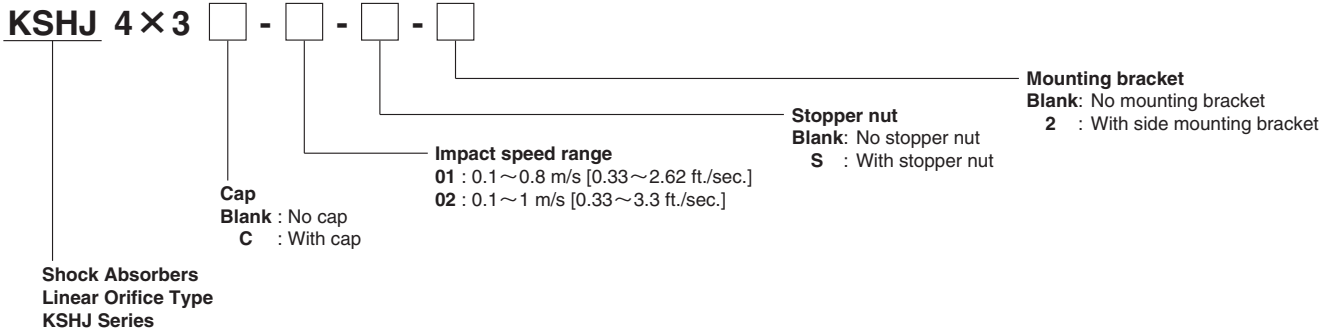

● 6 × 4

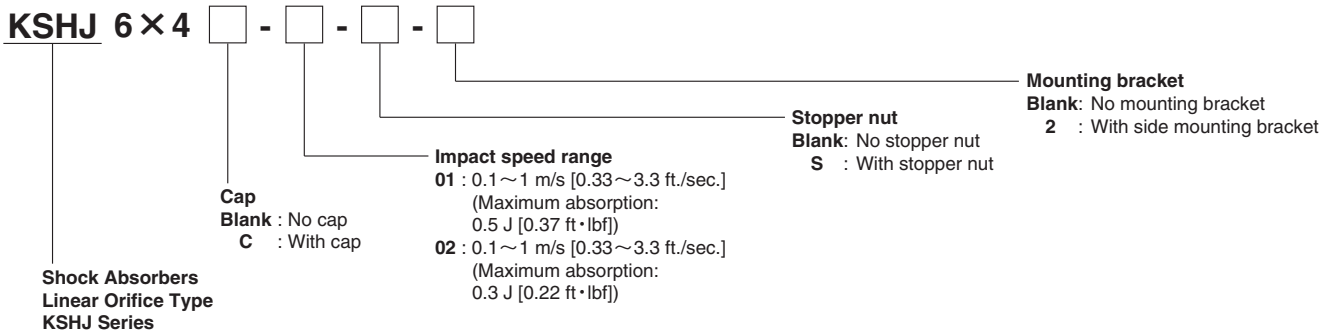

● 8 × 5

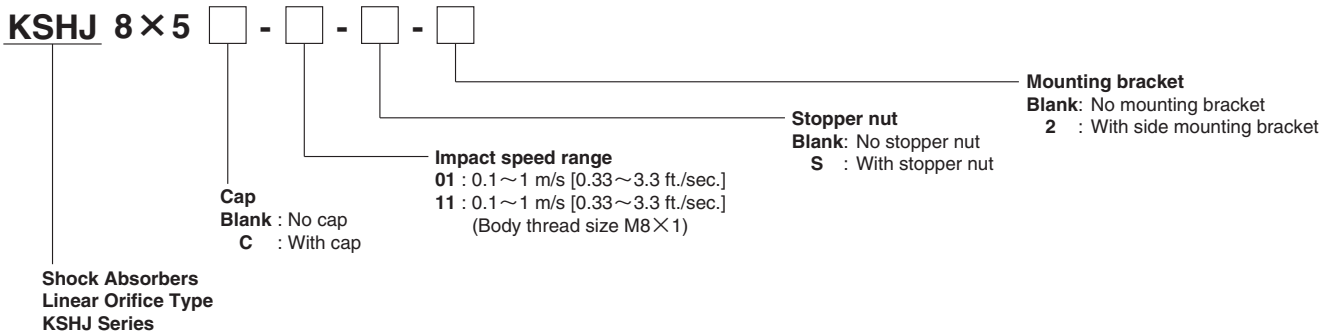

● 8 × 8

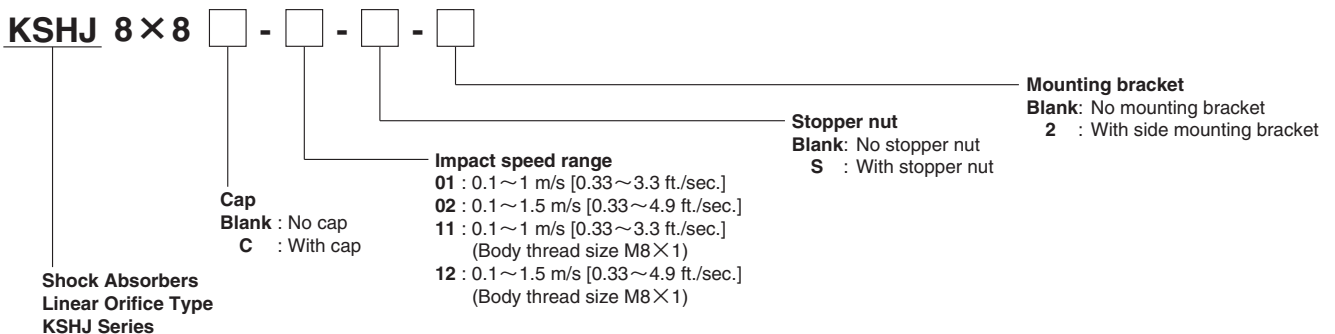

● 10 × 15

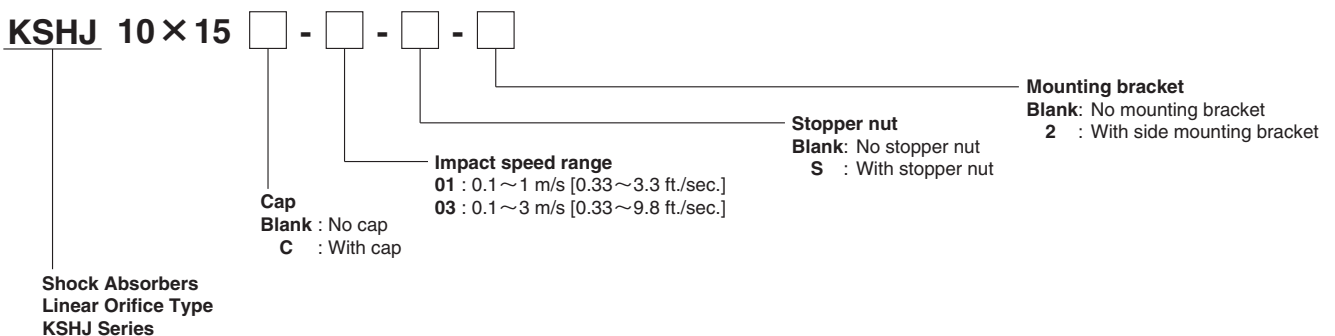

Order Codes

● 10 × 10, 12 × 10, 14 × 12, 16 × 15, 18 × 16, 20 × 16, 22 × 25

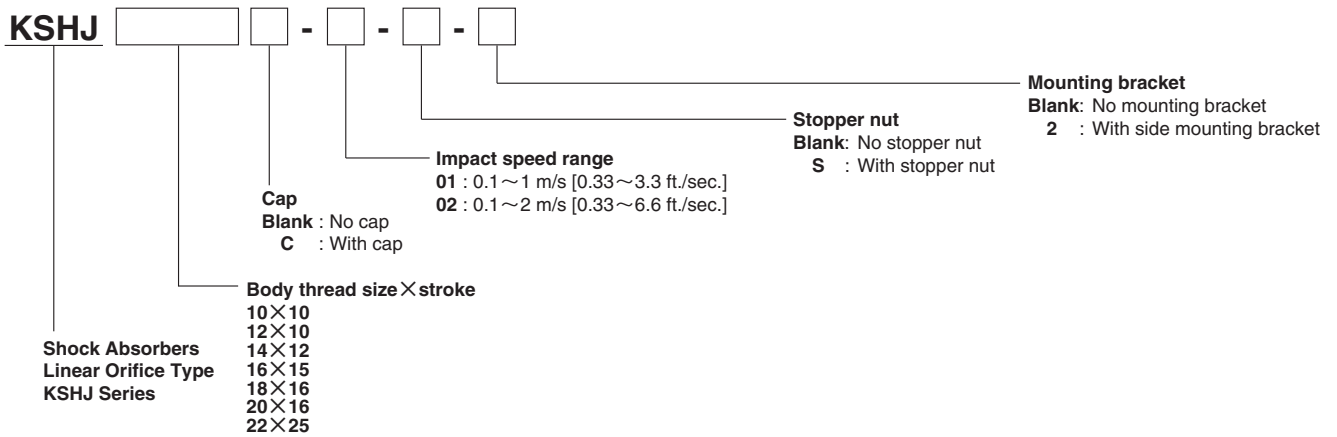

● 25 × 25

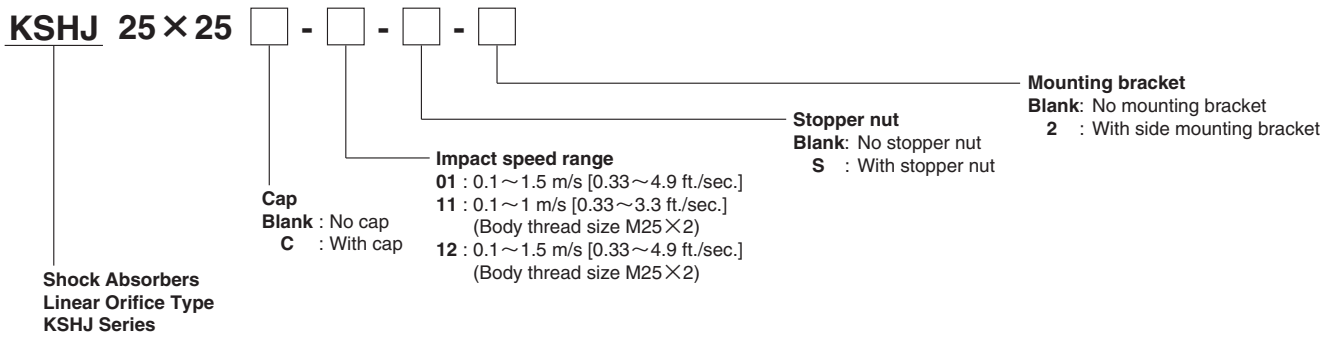

● 27 × 25

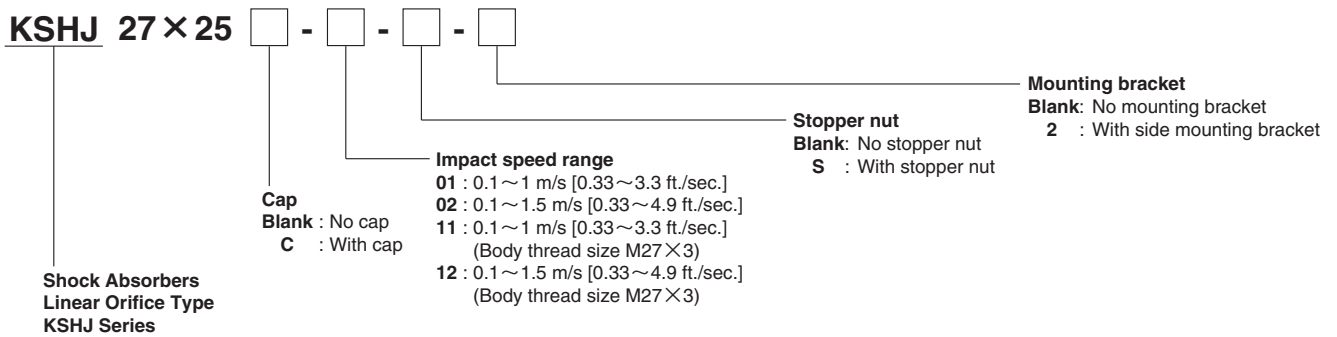

Additional Parts

● Side mounting bracket

2 - KSH - M []



Thread size
4 : M4 × 0.5
6 : M6 × 0.75
8 : M8 × 0.75
10 : M10 × 1
12 : M12 × 1
14 : M14 × 1.5
16 : M16 × 1.5
18 : M18 × 1.5
20 : M20 × 1.5
22 : M22 × 1.5
25 : M25 × 1.5
27 : M27 × 1.5

2-KSH-M8-11 (Thread size: M8 × 1)
2-KSH-M25-11 (Thread size: M25 × 2)
2-KSH-M27-11 (Thread size: M27 × 3)

● Stopper nut

S - KSH - M []



Thread size
4 : M4 × 0.5
6 : M6 × 0.75
8 : M8 × 0.75
10 : M10 × 1
12 : M12 × 1
14 : M14 × 1.5
16 : M16 × 1.5
18 : M18 × 1.5
20 : M20 × 1.5
22 : M22 × 1.5
25 : M25 × 1.5
27 : M27 × 1.5

S-KSH-M8-11 (Thread size: M8 × 1)
S-KSH-M25-11 (Thread size: M25 × 2)
S-KSH-M27-11 (Thread size: M27 × 3)

● Hexagon nut (M4~M20 : 10 nuts in one bag M22~M27 : Two nuts in one bag)

N - KSH - M []



Thread size
4 : M4 × 0.5
6 : M6 × 0.75
8 : M8 × 0.75
10 : M10 × 1
12 : M12 × 1
14 : M14 × 1.5
16 : M16 × 1.5
18 : M18 × 1.5
20 : M20 × 1.5
22 : M22 × 1.5
25 : M25 × 1.5
27 : M27 × 1.5

N-KSH-M8-11 (Thread size: M8 × 1)
N-KSH-M25-11 (Thread size: M25 × 2)
N-KSH-M27-11 (Thread size: M27 × 3)

Mass

g [oz.]

Model	Body mass	Additional mass (options)		
		Side mounting bracket	Stopper nut	With cap
KSHJ4×3-01, -02	1.8 [0.063]	8 [0.28]	0.8 [0.028]	0.1 [0.004]
KSHJ6×4-01, -02	4 [0.14]	9 [0.32]	2 [0.07]	0.2 [0.007]
KSHJ8×5-01, -11	10 [0.35]	12 [0.42]	4 [0.14]	0.5 [0.018]
KSHJ8×8-01, -02, -11, -12	11.5 [0.406]	12 [0.42]	4 [0.14]	0.5 [0.018]
KSHJ10×10-01, -02	22 [0.78]	15 [0.53]	7 [0.25]	0.6 [0.021]
KSHJ10×15-01, -03	28 [0.99]	15 [0.53]	7 [0.25]	0.6 [0.021]
KSHJ12×10-01, -02	37 [1.31]	22 [0.78]	8 [0.28]	1.2 [0.042]
KSHJ14×12-01, -02	58 [2.05]	43 [1.52]	15 [0.53]	1.4 [0.049]
KSHJ16×15-01, -02	83 [2.93]	87 [3.07]	29 [1.02]	1.4 [0.049]
KSHJ18×16-01, -02	113 [3.99]	128 [4.51]	38 [1.34]	3.0 [0.106]
KSHJ20×16-01, -02	156 [5.50]	175 [6.17]	50 [1.76]	3.0 [0.106]
KSHJ22×25-01, -02	233 [8.22]	550 [19.40]	80 [2.82]	7.0 [0.247]
KSHJ25×25-01	307 [10.83]	549 [19.37]	100 [3.53]	7.0 [0.247]
KSHJ25×25-11, -12	300 [10.58]	549 [19.37]	100 [3.53]	7.0 [0.247]
KSHJ27×25-01, -02	415 [14.64]	585 [20.63]	180 [6.35]	7.0 [0.247]
KSHJ27×25-11, -12	395 [13.93]	580 [20.46]	185 [6.53]	7.0 [0.247]

Calculation example: The mass of KSHJ10×10C-01-S-2 (with cap, with stopper nut, side mounting bracket) is $22 + 0.6 + 7 + 15 = 44.6$ g [1.573 oz.]

Inner Construction, Major Parts and Materials

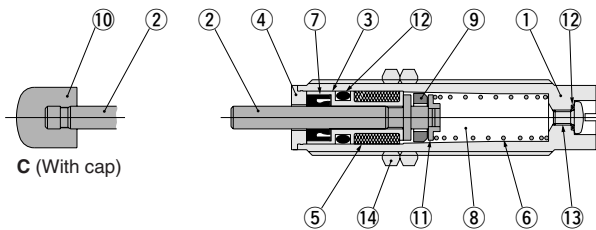

Note : Part shapes vary somewhat between sizes.

No.	Parts	Materials
①	Body	Copper alloy (nickel plated)
②	Piston rod	Steel (nickel plated)
③	Sleeve	Copper alloy
④	Plug	Stainless steel
⑤	Accumulator	Synthetic rubber
⑥	Spring	Spring steel
⑦	Rod seal	Synthetic rubber
⑧	Oil	Silicone oil
⑨	Piston ring	Copper alloy
⑩	Cap	Plastic (POM)
⑪	Collar	Steel, copper alloy
⑫	O-ring	Synthetic rubber
⑬	Screw	Mild steel (zinc plated)
⑭	Hexagon nut	Mild steel (nickel plated)

Dimensions mm [in.]

● No rod end cap: KSHJ4×3, KSHJ6×4

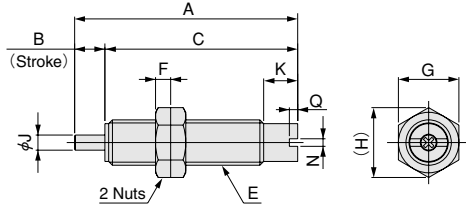

● With rod end cap: KSHJ4×3C, KSHJ6×4C

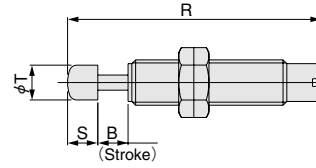

Model	Code	A	B	C	E	F	G	H	J	K	N	Q	R	S	T
KSHJ4×3(C)-01,-02		25 [0.984]	3 [0.118]	22 [0.866]	M4×0.5	2 [0.079]	5.5 [0.217]	6.4 [0.252]	1.2 [0.047]	3 [0.118]	1 [0.039]	1.1 [0.043]	28.5 [1.122]	3.5 [0.138]	3.2 [0.126]
KSHJ6×4(C)-01,-02		29.5 [1.161]	4 [0.157]	25.5 [1.004]	M6×0.75	2 [0.079]	8 [0.315]	9.2 [0.362]	2 [0.079]	4.5 [0.177]	1 [0.039]	1 [0.039]	33.5 [1.319]	4 [0.157]	4.6 [0.181]

● No rod end cap: KSHJ□×□-□

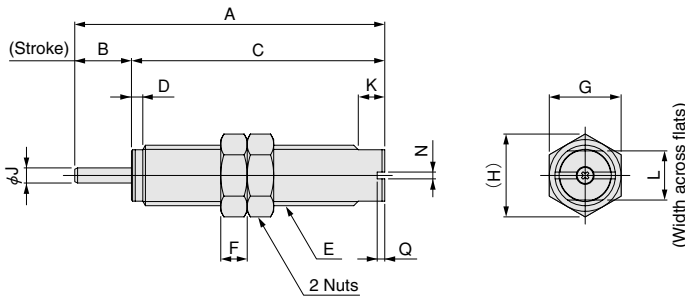

● With rod end cap: KSHJ□×□C-□

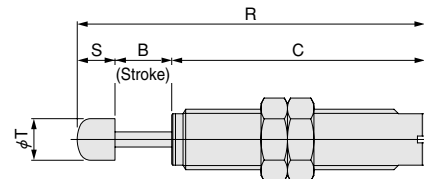

Model	Code	A	B	C	D	E	F	G	H	J	K	L	N	Q	R	S	T
KSHJ8×5(C)-01		37 [1.457]	5 [0.197]	32 [1.260]	1.2 [0.047]	M8×0.75	2 [0.079]	10 [0.394]	11.5 [0.453]	2.5 [0.098]	3 [0.118]	7 [0.276]	1.3 [0.051]	1.5 [0.059]	42 [1.654]	5 [0.197]	6.5 [0.256]
KSHJ8×5(C)-11		37 [1.457]	5 [0.197]	32 [1.260]	1.2 [0.047]	M8×1	3 [0.118]	10 [0.394]	11.5 [0.453]	2.5 [0.098]	3 [0.118]	7 [0.276]	1.3 [0.051]	1.5 [0.059]	42 [1.654]	5 [0.197]	6.5 [0.256]
KSHJ8×8(C)-01,-02		46 [1.811]	8 [0.315]	38 [1.496]	1.2 [0.047]	M8×0.75	2 [0.079]	10 [0.394]	11.5 [0.453]	2.5 [0.098]	3 [0.118]	7 [0.276]	1.3 [0.051]	1.5 [0.059]	51 [2.008]	5 [0.197]	6.5 [0.256]
KSHJ8×8(C)-11,-12		46 [1.811]	8 [0.315]	38 [1.496]	1.2 [0.047]	M8×1	3 [0.118]	10 [0.394]	11.5 [0.453]	2.5 [0.098]	3 [0.118]	7 [0.276]	1.3 [0.051]	1.5 [0.059]	51 [2.008]	5 [0.197]	6.5 [0.256]
KSHJ10×10(C)-01,-02		60 [2.362]	10 [0.394]	50 [1.969]	2 [0.079]	M10×1	3 [0.118]	12 [0.472]	13.9 [0.547]	3 [0.118]	5 [0.197]	8.5 [0.335]	1.3 [0.051]	1.5 [0.059]	68 [2.677]	8 [0.315]	8 [0.315]
KSHJ10×15(C)-01,-03		77 [3.031]	15 [0.591]	62 [2.441]	2.3 [0.091]	M10×1	3 [0.118]	12 [0.472]	13.9 [0.547]	3 [0.118]	5 [0.197]	8.5 [0.335]	1.3 [0.051]	1.5 [0.059]	85 [3.346]	8 [0.315]	8 [0.315]
KSHJ12×10(C)-01,-02		66 [2.598]	10 [0.394]	56 [2.205]	2 [0.079]	M12×1	4 [0.157]	14 [0.551]	16.2 [0.638]	3 [0.118]	5 [0.197]	10.5 [0.413]	1.3 [0.051]	1.5 [0.059]	76 [2.992]	10 [0.394]	10 [0.394]
KSHJ14×12(C)-01,-02		72 [2.835]	12 [0.472]	60 [2.362]	2 [0.079]	M14×1.5	5 [0.197]	17 [0.669]	19.6 [0.772]	4 [0.157]	5 [0.197]	12 [0.472]	1.3 [0.051]	1.5 [0.059]	82 [3.228]	10 [0.394]	11 [0.433]
KSHJ16×15(C)-01,-02		82 [3.228]	15 [0.591]	67 [2.638]	3 [0.118]	M16×1.5	7 [0.276]	19 [0.748]	21.9 [0.862]	4 [0.157]	7 [0.276]	13 [0.512]	1.8 [0.071]	2 [0.079]	92 [3.622]	10 [0.394]	11 [0.433]
KSHJ18×16(C)-01,-02		88 [3.465]	16 [0.630]	72 [2.835]	3 [0.118]	M18×1.5	8 [0.315]	21 [0.827]	24.2 [0.953]	5 [0.197]	7 [0.276]	15 [0.591]	1.8 [0.071]	2 [0.079]	103 [4.055]	15 [0.591]	15 [0.591]
KSHJ20×16(C)-01,-02		93 [3.661]	16 [0.630]	77 [3.031]	3 [0.118]	M20×1.5	8 [0.315]	24 [0.945]	27.7 [1.091]	5 [0.197]	7 [0.276]	17 [0.669]	1.8 [0.071]	2 [0.079]	108 [4.252]	15 [0.591]	15 [0.591]
KSHJ22×25(C)-01,-02		125 [4.921]	25 [0.984]	100 [3.937]	3 [0.118]	M22×1.5	9 [0.354]	27 [1.063]	31.2 [1.228]	6 [0.236]	10 [0.394]	19 [0.748]	1.8 [0.071]	2 [0.079]	143 [5.630]	18 [0.709]	18 [0.709]
KSHJ25×25(C)-01		125 [4.921]	25 [0.984]	100 [3.937]	3 [0.118]	M25×1.5	10 [0.394]	30 [1.181]	34.6 [1.362]	6 [0.236]	10 [0.394]	22 [0.866]	1.8 [0.071]	2 [0.079]	143 [5.630]	18 [0.709]	18 [0.709]
KSHJ25×25(C)-11,-12		125 [4.921]	25 [0.984]	100 [3.937]	3 [0.118]	M25×2	10 [0.394]	30 [1.181]	34.6 [1.362]	6 [0.236]	10 [0.394]	22 [0.866]	1.8 [0.071]	2 [0.079]	143 [5.630]	18 [0.709]	18 [0.709]

● No rod end cap: KSHJ27×25-□

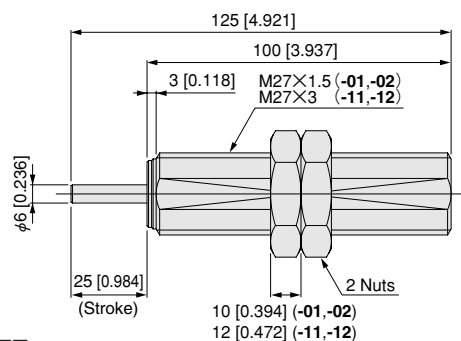

● With rod end cap: KSHJ27×25C-□

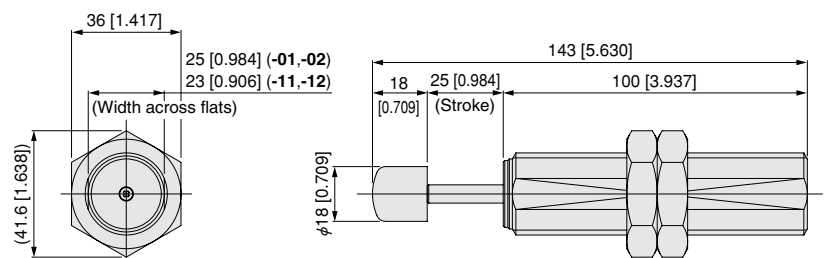

Dimensions of Additional Parts mm [in.]

● Side mounting bracket: 2-KSH-□-□ (-2)

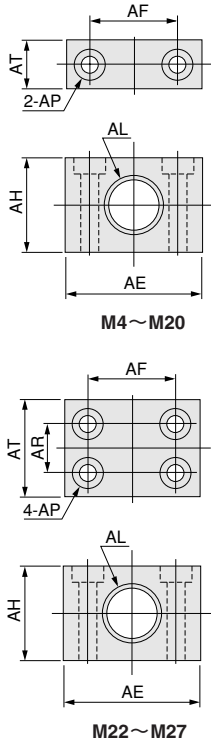

Model	Code	AE	AF	AH	AL	AP	AR	AT
2-KSH-M4		18 [0.709]	12 [0.472]	8 [0.315]	M4×0.5	φ 3.4 [0.134], Counterbore φ 6.5 [0.256] Depth 3.3 [0.130]	—	8 [0.315]
2-KSH-M6		18 [0.709]	12 [0.472]	10 [0.394]	M6×0.75	φ 3.4 [0.134], Counterbore φ 6.5 [0.256] Depth 3.3 [0.130]	—	8 [0.315]
2-KSH-M8		19 [0.748]	13 [0.512]	13 [0.512]	M8×0.75	φ 3.4 [0.134], Counterbore φ 6.5 [0.256] Depth 3.3 [0.130]	—	9 [0.354]
2-KSH-M8-11		19 [0.748]	13 [0.512]	13 [0.512]	M8×1	φ 3.4 [0.134], Counterbore φ 6.5 [0.256] Depth 3.3 [0.130]	—	9 [0.354]
2-KSH-M10		22 [0.866]	14 [0.551]	14 [0.551]	M10×1	φ 3.4 [0.134], Counterbore φ 6.5 [0.256] Depth 3.3 [0.130]	—	9 [0.354]
2-KSH-M12		25 [0.948]	16 [0.630]	18 [0.709]	M12×1	φ 3.4 [0.134], Counterbore φ 6.5 [0.256] Depth 3.3 [0.130]	—	9 [0.354]
2-KSH-M14		34 [1.339]	22 [0.866]	22 [0.866]	M14×1.5	φ 4.5 [0.177], Counterbore φ 8 [0.315] Depth 4.5 [0.177]	—	10 [0.394]
2-KSH-M16		38 [1.496]	25 [0.984]	25 [0.984]	M16×1.5	φ 4.5 [0.177], Counterbore φ 8 [0.315] Depth 4.5 [0.177]	—	12 [0.472]
2-KSH-M18		50 [1.969]	34 [1.339]	30 [1.181]	M18×1.5	φ 6.5 [0.256], Counterbore φ 11 [0.433] Depth 6.5 [0.256]	—	12 [0.472]
2-KSH-M20		50 [1.969]	34 [1.339]	30 [1.181]	M20×1.5	φ 9 [0.354], Counterbore φ 14 [0.551] Depth 8.5 [0.335]	—	16 [0.630]
2-KSH-M22		60 [2.362]	44 [1.732]	35 [1.378]	M22×1.5	φ 9 [0.354], Counterbore φ 14 [0.551] Depth 8.5 [0.335]	19 [0.748]	35 [1.378]
2-KSH-M25		60 [2.362]	44 [1.732]	35 [1.378]	M25×1.5	φ 9 [0.354], Counterbore φ 14 [0.551] Depth 8.5 [0.335]	19 [0.748]	35 [1.378]
2-KSH-M25-11		60 [2.362]	44 [1.732]	35 [1.378]	M25×2	φ 9 [0.354], Counterbore φ 14 [0.551] Depth 8.5 [0.335]	19 [0.748]	35 [1.378]
2-KSH-M27		60 [2.362]	44 [1.732]	44 [1.732]	M27×1.5	φ 9 [0.354], Counterbore φ 14 [0.551] Depth 8.5 [0.335]	19 [0.748]	35 [1.378]
2-KSH-M27-11		60 [2.362]	44 [1.732]	44 [1.732]	M27×3	φ 9 [0.354], Counterbore φ 14 [0.551] Depth 8.5 [0.335]	19 [0.748]	35 [1.378]

● Stopper nut: S-KSH-□-□ (-S)

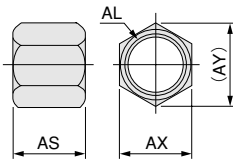

Model	Code	AL	AS	AX	AY
S-KSH-M4		M4×0.5	7.5 [0.295]	5.5 [0.217]	6.4 [0.252]
S-KSH-M6		M6×0.75	7 [0.276]	8 [0.315]	9.2 [0.362]
S-KSH-M8		M8×0.75	11 [0.433]	10 [0.394]	11.5 [0.453]
S-KSH-M8-11		M8×1	11 [0.433]	10 [0.394]	11.5 [0.453]
S-KSH-M10		M10×1	17 [0.669]	12 [0.472]	13.9 [0.547]
S-KSH-M12		M12×1	17 [0.669]	14 [0.551]	16.2 [0.638]
S-KSH-M14		M14×1.5	18 [0.709]	17 [0.669]	19.6 [0.772]
S-KSH-M16		M16×1.5	30 [1.181]	19 [0.748]	21.9 [0.862]
S-KSH-M18		M18×1.5	35 [1.378]	21 [0.827]	24.2 [0.953]
S-KSH-M20		M20×1.5	35 [1.378]	24 [0.945]	27.7 [1.091]
S-KSH-M22		M22×1.5	40 [1.575]	27 [1.063]	31.2 [1.228]
S-KSH-M25		M25×1.5	40 [1.575]	30 [1.181]	34.6 [1.362]
S-KSH-M25-11		M25×2	40 [1.575]	30 [1.181]	34.6 [1.362]
S-KSH-M27		M27×1.5	40 [1.575]	36 [1.417]	41.6 [1.638]
S-KSH-M27-11		M27×3	40 [1.575]	36 [1.417]	41.6 [1.638]

● Hexagon nut: N-KSH-□-□

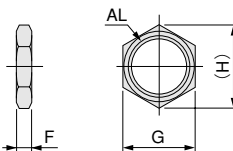

Model	Code	AL	F	G	H
N-KSH-M4		M4×0.5	2 [0.079]	5.5 [0.217]	6.4 [0.252]
N-KSH-M6		M6×0.75	2 [0.079]	8 [0.315]	9.2 [0.362]
N-KSH-M8		M8×0.75	2 [0.079]	10 [0.394]	11.5 [0.453]
N-KSH-M8-11		M8×1	3 [0.118]	10 [0.394]	11.5 [0.453]
N-KSH-M10		M10×1	3 [0.118]	12 [0.472]	13.9 [0.547]
N-KSH-M12		M12×1	4 [0.157]	14 [0.551]	16.2 [0.638]
N-KSH-M14		M14×1.5	5 [0.197]	17 [0.669]	19.6 [0.772]
N-KSH-M16		M16×1.5	7 [0.276]	19 [0.748]	21.9 [0.862]
N-KSH-M18		M18×1.5	8 [0.315]	21 [0.827]	24.2 [0.953]
N-KSH-M20		M20×1.5	8 [0.315]	24 [0.945]	27.7 [1.091]
N-KSH-M22		M22×1.5	9 [0.354]	27 [1.063]	31.2 [1.228]
N-KSH-M25		M25×1.5	10 [0.394]	30 [1.181]	34.6 [1.362]
N-KSH-M25-11		M25×2	10 [0.394]	30 [1.181]	34.6 [1.362]
N-KSH-M27		M27×1.5	10 [0.394]	36 [1.417]	41.6 [1.638]
N-KSH-M27-11		M27×3	12 [0.472]	36 [1.417]	41.6 [1.638]

SHOCK ABSORBERS

LINEAR ORIFICE TYPE

KSHA Series

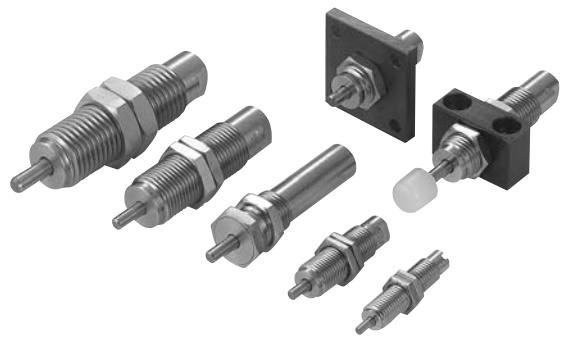

Specifications

Item	Model	KSHA4×4□-A	KSHA4×4□-B	KSHA4×4□-BD
Mounting thread size		M6×0.75		
Maximum absorption	J [ft·lbf]	0.1 [0.07]	0.3 [0.22]	0.5 [0.37]
Absorbing stroke	mm [in.]	4 [0.16]		
Maximum impact speed	m/s [ft./sec.]	1.0 [3.28]		
Maximum operating frequency	cycle/min	60		
Spring return force	N [lbf.]	3.0 [0.67]		
Angle variation		1° or less		
Operating temperature range ^{Note}	°C [°F]	0~60 [32~140]		

Item	Model	KSHA5×5□-B	KSHA5×5□-D	KSHA5×5□-E
Mounting thread size		M8×0.75		
Maximum absorption	J [ft·lbf]	0.3 [0.22]	1.0 [0.74]	2.0 [1.48]
Absorbing stroke	mm [in.]	5 [0.20]		
Maximum impact speed	m/s [ft./sec.]	1.0 [3.28]		
Maximum operating frequency	cycle/min	60		
Spring return force	N [lbf.]	6.0 [1.35]		
Angle variation		1° or less		
Operating temperature range ^{Note}	°C [°F]	0~60 [32~140]		

Item	Model	KSHA6×5□-A	KSHA6×5□-B	KSHA6×5□-D	KSHA6×5□-DE
Mounting thread size		M10×1			
Maximum absorption	J [ft·lbf]	0.1 [0.07]	0.3 [0.22]	1.0 [0.74]	1.5 [1.11]
Absorbing stroke	mm [in.]	5 [0.20]			
Maximum impact speed	m/s [ft./sec.]	1.0 [3.28]			
Maximum operating frequency	cycle/min	60			
Spring return force	N [lbf.]	6.0 [1.35]			
Angle variation		1° or less			
Operating temperature range ^{Note}	°C [°F]	0~60 [32~140]			

Item	Model	KSHA6×8□-D	KSHA6×8□-E	KSHA6×8□-F	KSHA7×8□-G	KSHA7×8□-K
Mounting thread size		M10×1			M12×1	
Maximum absorption	J [ft·lbf]	1.0 [0.74]	2.0 [1.48]	2.9 [2.14]	3.9 [2.88]	5.9 [4.35]
Absorbing stroke	mm [in.]	8 [0.31]				
Maximum impact speed	m/s [ft./sec.]	1.0 [3.28]				
Maximum operating frequency	cycle/min	30				
Spring return force	N [lbf.]	8.5 [1.91]				
Angle variation		3° or less				
Operating temperature range ^{Note}	°C [°F]	0~60 [32~140]				

Item	Model	KSHA8×10□-GK	KSHA8×10□-L
Mounting thread size		M14×1.5	
Maximum absorption	J [ft·lbf]	5.0 [3.69]	8.0 [5.90]
Absorbing stroke	mm [in.]	10 [0.39]	
Maximum impact speed	m/s [ft./sec.]	1.0 [3.28]	
Maximum operating frequency	cycle/min	30	
Spring return force	N [lbf.]	8.5 [1.91]	
Angle variation		3° or less	
Operating temperature range ^{Note}	°C [°F]	0~60 [32~140]	

Note: Shock absorption capacity fluctuates depending on ambient temperature or speed.

Selection Guideline

Precautions for Use of Selection Graphs

1. The selection graphs show the best conditions for usage of the product with horizontal impacts.
2. The selection graphs are calculated for a cylinder with air pressure of 0.5 MPa [73 psi.].

● Selection Graphs

KSHA4 × 4

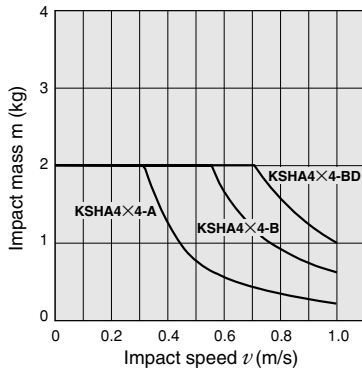

KSHA5 × 5

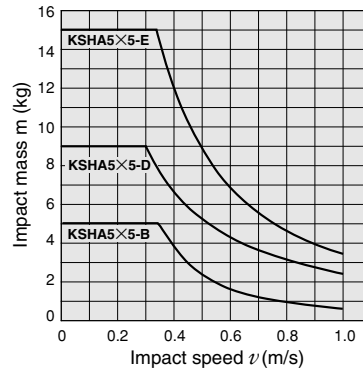

KSHA6 × 5

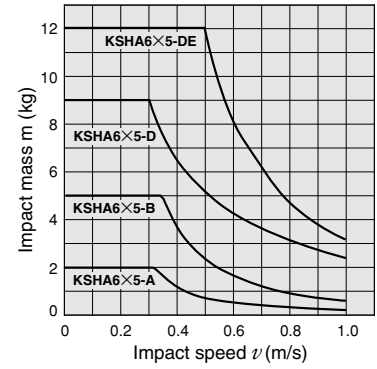

KSHA6 × 8

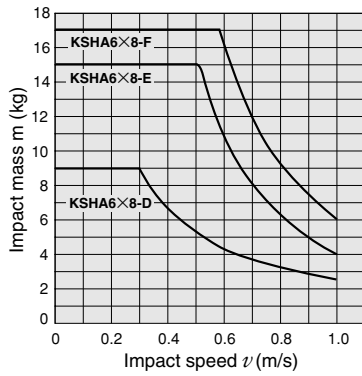

KSHA7 × 8

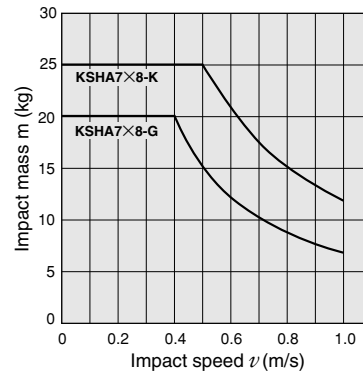

KSHA8 × 10

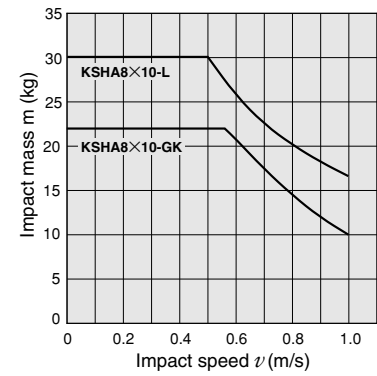

1 kg = 2.20 lb. 1 m/s = 3.28 ft./sec.

Mass

g [oz.]

Model	Body mass		Additional mass (options)			
	Nose mounting	Insert mounting	Side mounting bracket	Flange mounting bracket	Stopper nut	With cap
KSHA4×4	4 [0.14]	—	9 [0.32]	7 [0.25]	2 [0.07]	0.2 [0.007]
KSHA5×5	7 [0.25]	—	12 [0.42]	13 [0.46]	2 (4) [0.07] ([0.14]) ^{Note}	1 [0.035]
KSHA6×5	10 [0.35]	—	15 [0.53]	16 [0.56]	4 (7) [0.14] ([0.25]) ^{Note}	1 [0.035]
KSHA6×8	20 [0.71]	21 [0.74]	15 [0.53]	16 [0.56]	7 [0.25]	1 [0.035]
KSHA7×8	28 [0.99]	29 [1.02]	22 [0.78]	15 [0.53]	8 [0.28]	1 [0.035]
KSHA8×10	48 [1.69]	—	43 [1.52]	32 [1.13]	15 [0.53]	1 [0.035]

Note: () shows with cap.

Remarks: 1. Supplied with two mounting nuts for nose mounting, with one mounting nut for insert mounting.

2. Supplied with two mounting screws for side mounting type.

Calculation sample: The mass of KSHA 6×8 nose mounting, with side mounting brackets and stopper nut. 20+15+7=42 g [1.48 oz.]

Order Codes

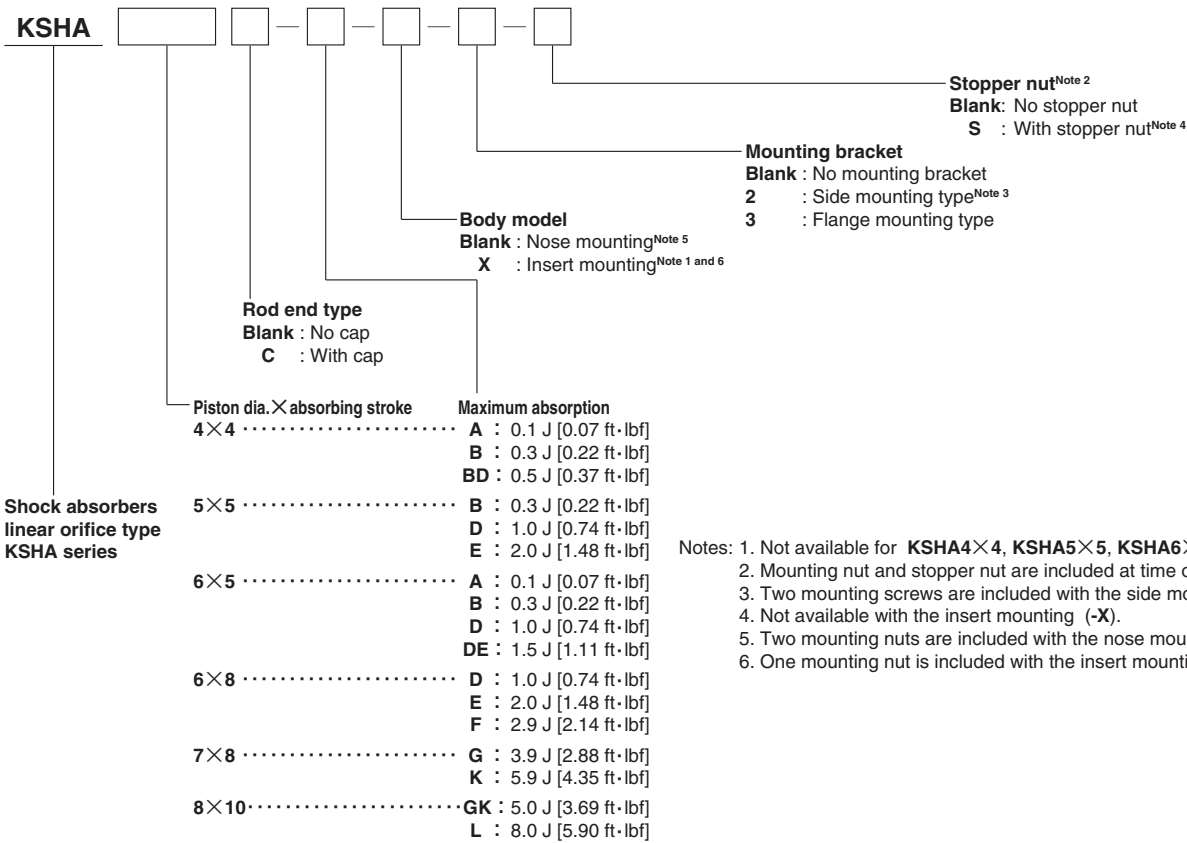

Inner Construction, Major Parts and Materials

- KSHA4×4
- KSHA5×5

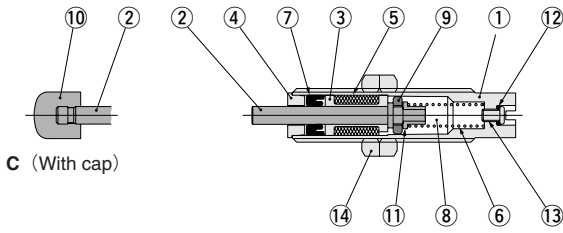

- KSHA4×4, 5×5

No.	Parts	Materials
①	Body	Copper alloy (nickel plated) (4×4: free-cutting steel (nickel plated))
②	Piston rod	Steel
③	Sleeve	Copper alloy
④	Plug	Stainless steel
⑤	Accumulator	Synthetic rubber
⑥	Spring	Spring steel
⑦	Rod seal	Synthetic rubber
⑧	Oil	Special oil
⑨	Piston ring	Copper alloy
⑩	Cap	Plastic (POM)
⑪	Collar	Copper alloy
⑫	O-ring	Synthetic rubber
⑬	Screw	Mild steel (zinc plated)
⑭	Hexagon nut	Mild steel (zinc plated)

- KSHA6×5
- KSHA6×8
- KSHA7×8
- KSHA8×10

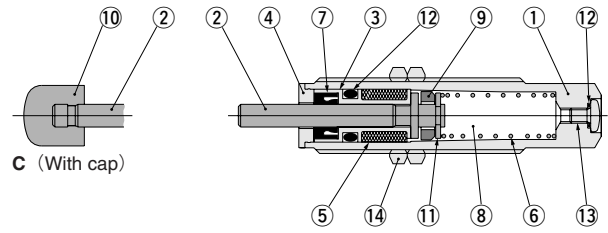

Note : Part shapes vary somewhat between sizes.

- KSHA6×5, 6×8, 7×8, 8×10

No.	Parts	Materials
①	Body	Copper alloy (nickel plated)
②	Piston rod	Steel
③	Sleeve	Copper alloy
④	Plug	Stainless steel
⑤	Accumulator	Synthetic rubber
⑥	Spring	Spring steel
⑦	Rod seal	Synthetic rubber
⑧	Oil	Special oil
⑨	Piston ring	Copper alloy
⑩	Cap	Plastic (POM)
⑪	E-ring	Steel
⑫	O-ring	Synthetic rubber
⑬	Screw	Mild steel (zinc plated)
⑭	Hexagon nut	Mild steel (zinc plated)

Dimensions (mm)

● Nose mounting

● No rod end cap: KSHA4×4

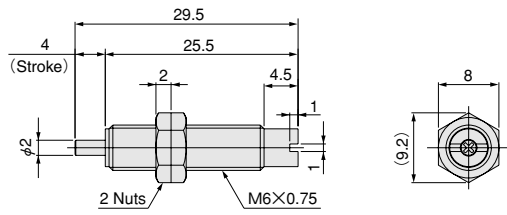

● With rod end cap: KSHA4×4C

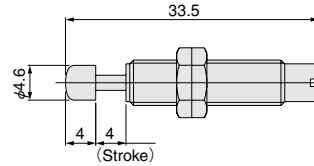

● No rod end cap: KSHA□×□

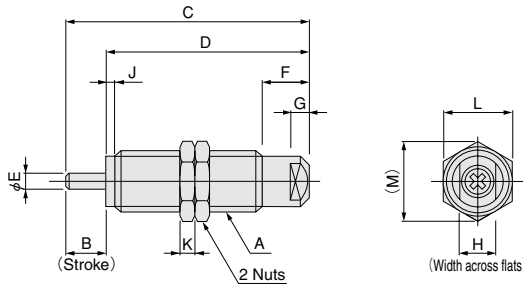
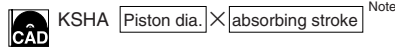

● With rod end cap: KSHA□×□C



Note : Not available for KSHA8×10□.

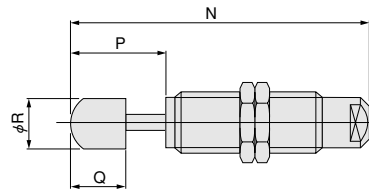

Model	Code	A	B	C	D	E	F	G	H	J	K	L	M	N	P	Q	R
KSHA5×5□	M8×0.75	5	31	26	2.5	6	3	5	1.2	2	10	11.5	36	10	5	6.5	
KSHA6×5□	M10×1	5	30.5	25.5	3	7	3.5	6	2	3	12	13.9	38.5	13	8	8	
KSHA6×8□	M10×1	8	48	40	3	10	4	6	2	3	12	13.9	56	16	8	8	
KSHA7×8□	M12×1	8	48	40	3	10	4	8	2	3	14	16.2	58	18	10	10	
KSHA8×10□	M14×1.5	10	60	50	4	10	5	8	2	5	17	19.6	70	20	10	11	

● Insert mounting

● No rod end cap: KSHA□×□-X

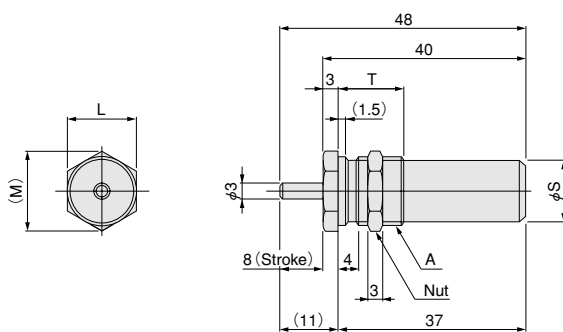
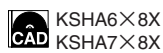

● Mounting hole for insert type

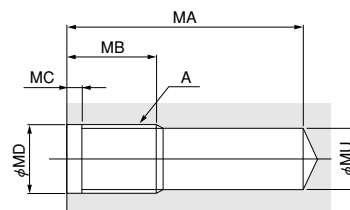

● With rod end cap : KSHA□×□C-X

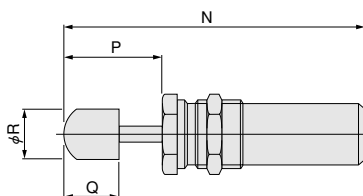

Model	Code	A	N	P	Q	R	S	T	MA	MB	MC	MD	MU	L	M
KSHA6×8□-X	M10×1	56	16	8	8	8.5	12	Min. 38	Min. 13	2	10 ^{+0.5} _{+0.1}	9	12	13.9	
KSHA7×8□-X	M12×1	58	18	10	10	10.5	14	Min. 38	Min. 13	2	12 ^{+0.5} _{+0.1}	11	14	16.2	

Dimensions of Mounting Bracket (mm)

● Side mounting bracket: -2 S-SIDE ^{Note}

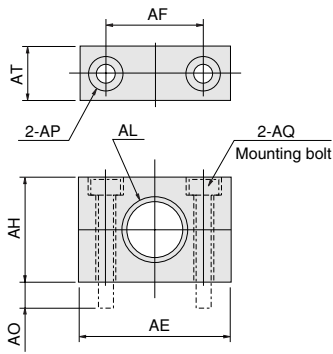

Code	AE	AF	AH	AL	AO	AP	AQ	AT
Model							(Hexagon socket head screw)	
For KSHA4 ×4□	18	12	10	M6×0.75	(5.3)	φ 3.4 Counterbore φ 6.5 Depth 3.3	M3×0.5 Screw length 12	8
For KSHA5 ×5□	19	13	13	M8×0.75	(4.3)	φ 3.4 Counterbore φ 6.5 Depth 3.3	M3×0.5 Screw length 14	9
For KSHA6 ×5□	22	14	14	M10×1 Counterbore φ 10.2 Depth 2	(9.3)	φ 3.4 Counterbore φ 6.2 Depth 3.3	M3×0.5 Screw length 20	9
For KSHA6 ×8□								
For KSHA7 ×8□	25	16	18	M12×1 Counterbore φ 12.2 Depth 2	(5.3)	φ 3.4 Counterbore φ 6.2 Depth 3.3	M3×0.5 Screw length 20	9
For KSHA8 ×10□	34	22	22	M14×1.5	(7.5)	φ 4.5 Counterbore φ 8 Depth 4.5	M4×0.7 Screw length 25	10

● Mounting screws (hexagon socket head screws) are supplied with a side mounting bracket.

● Flange mounting bracket: -3 S-FLANGE ^{Note}

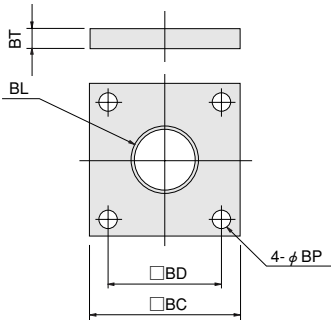

Code	BC	BD	BL	BP	BT
Model					
For KSHA4 ×4□	18	12	M6×0.75	3.4	3
For KSHA5 ×5□	22	15	M8×0.75	3.2	4
For KSHA6 ×5□					
For KSHA6 ×8□	25	18	M10×1 Counterbore φ 10.2 Depth 1.7	3.2	4
For KSHA7 ×8□	25	18	M12×1 Counterbore φ 12.2 Depth 1.7	3.2	4
For KSHA8 ×10□	32	22	M14×1.5	4.5	6

● Stopper nut: -S S-STOPER ^{Note}

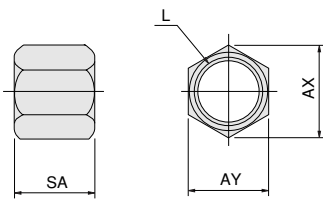

Code	L	AX	AY	SA
Model				
For KSHA4 ×4□	M6×0.75	9.2	8	7
For KSHA5 ×5□	M8×0.75	11.5	10	6
For KSHA5 ×5C□				11
For KSHA6 ×5□	M10×1	13.9	12	8
For KSHA6 ×5C□				17
For KSHA6 ×8□				17
For KSHA7 ×8□	M12×1	16.2	14	17
For KSHA8 ×10□	M14×1.5	19.6	17	18

Note: Not available for **KSHA4**×4□, **KSHA8**×10□.

CLEAN ROOM SPECIFICATION
SHOCK ABSORBERS
 LINEAR ORIFICE TYPE

KSHC Series

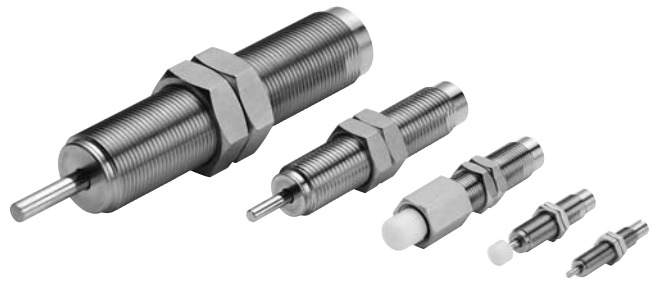

Specifications

Item	Model	CS-KSHC4×4□-B	CS-KSHC4×4□-BD	CS-KSHC5×5□-D(-11)	CS-KSHC5×5□-DE(-11)
Mounting thread size		M6×0.75		M8×0.75(M8×1) ^{Note2}	
Maximum absorption	J [ft·lbf]	0.3 [0.22]	0.5 [0.37]	1.0 [0.74]	1.5 [1.11]
Absorbing stroke	mm [in.]	4 [0.16]		5 [0.20]	
Maximum impact speed	m/s [ft./sec.]	1.0 [3.28]			
Maximum operating frequency	cycle/min	60			
Maximum absorption per unit of time	J/min [ft·lbf/min.]	15 [11.1]		45 [33.2]	
Spring return force	N [lbf.]	3.0 [0.67]		6.0 [1.35]	
Angle variation		1° or less			
Operating temperature range ^{Note1}	°C [°F]	0~60 [32~140]			

Item	Model	CS-KSHC6×8□-DE	CS-KSHC6×8□-EF	CS-KSHC8×8□-EF	CS-KSHC8×8□-G
Mounting thread size		M10×1		M12×1	
Maximum absorption	J [ft·lbf]	1.5 [1.11]	2.5 [1.84]	2.5 [1.84]	4.0 [2.95]
Absorbing stroke	mm [in.]	8 [0.32]			
Maximum impact speed	m/s [ft./sec.]	1.0 [3.28]			
Maximum operating frequency	cycle/min	60			
Maximum absorption per unit of time	J/min [ft·lbf/min.]	75 [55.3]		120 [89]	
Spring return force	N [lbf.]	8.5 [1.91]			
Angle variation		1° or less			
Operating temperature range ^{Note1}	°C [°F]	0~60 [32~140]			

Item	Model	CS-KSHC9×10□-GK	CS-KSHC9×10□-L	CS-KSHC11×15□-M	CS-KSHC11×15□-P
Mounting thread size		M14×1.5		M16×1.5	
Maximum absorption	J [ft·lbf]	5.0 [3.69]	8.0 [5.90]	10 [7.4]	15 [11.1]
Absorbing stroke	mm [in.]	10 [0.39]		15 [0.59]	
Maximum impact speed	m/s [ft./sec.]	1.0 [3.28]			
Maximum operating frequency	cycle/min	60		40	
Maximum absorption per unit of time	J/min [ft·lbf/min.]	240 [177]		300 [221]	
Spring return force	N [lbf.]	8.5 [1.91]		18 [4.0]	
Angle variation		1° or less			
Operating temperature range ^{Note1}	°C [°F]	0~60 [32~140]			

Item	Model	CS-KSHC14×16□-R	CS-KSHC14×16□-T	CS-KSHC18×25□-X	
Mounting thread size		M20×1.5		M25×1.5	
Maximum absorption	J [ft·lbf]	20 [14.8]	30 [22.1]	40 [29.5]	
Absorbing stroke	mm [in.]	16 [0.63]		25 [0.98]	
Maximum impact speed	m/s [ft./sec.]	1.0 [3.28]			
Maximum operating frequency	cycle/min	40			
Maximum absorption per unit of time	J/min [ft·lbf/min.]	600 [443]		800 [590]	
Spring return force	N [lbf.]	18.6 [4.18]		32 [7.2]	
Angle variation		1° or less			
Operating temperature range ^{Note1}	°C [°F]	0~60 [32~140]			

Notes: 1. Shock absorption capacity fluctuates depending on ambient temperature or speed.
 2. The value inside () is CS-KSHC5×5□-□-11.

Selection Guideline

Precautions for Use of Selection Graphs

1. The selection graphs show the best conditions for usage of the product with horizontal impacts.
2. The selection graphs are calculated for a cylinder with air pressure of 0.5 MPa [73 psi.].

● Selection Graphs

CS-KSHC4 × 4

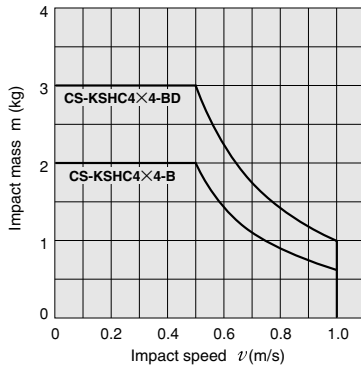

CS-KSHC5 × 5

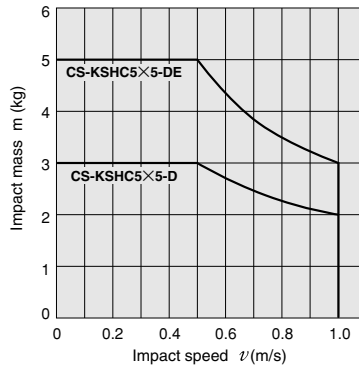

CS-KSHC6 × 8

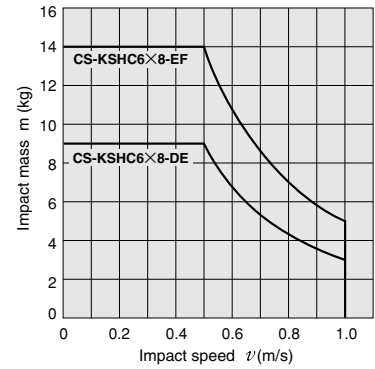

CS-KSHC8 × 8

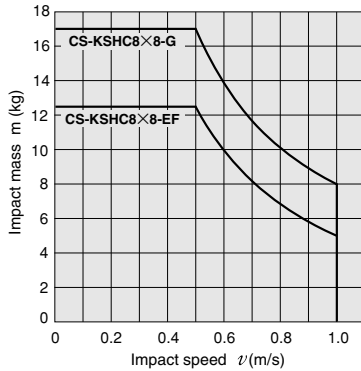

CS-KSHC9 × 10

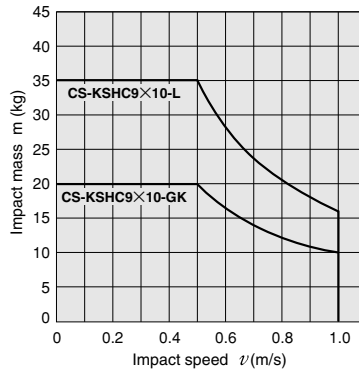

CS-KSHC11 × 15

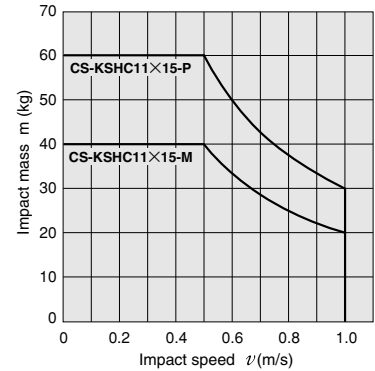

CS-KSHC14 × 16

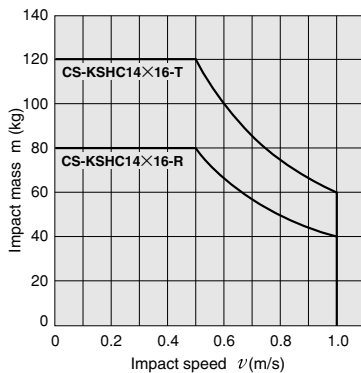

CS-KSHC18 × 25

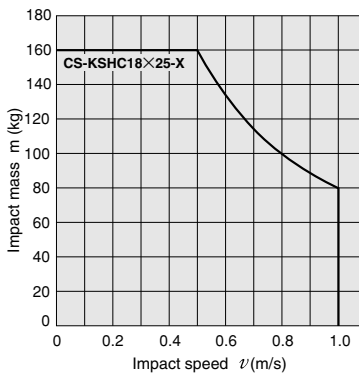

1 kg = 2.20 lb. 1 m/s = 3.28 ft./sec.

SHOCK ABSORBERS

■ Recommended bore size

Model	Bore size mm [in.]	φ 6 [0.236]	φ 8 [0.315]	φ 10 [0.394]	φ 16 [0.630]	φ 20 [0.787]	φ 25 [0.984]	φ 32 [1.260]	φ 40 [1.575]	φ 50 [1.969]	φ 63 [2.480]	φ 80 [3.150]	φ 100 [3.937]
CS-KSHC4 × 4		○	○	○									
CS-KSHC5 × 5			○	○	○								
CS-KSHC6 × 8				○	○	○							
CS-KSHC8 × 8					○	○	○						
CS-KSHC9 × 10					○	○	○	○					
CS-KSHC11 × 15						○	○	○	○				
CS-KSHC14 × 16								○	○	○	○		
CS-KSHC18 × 25									○	○	○	○	○

Note: The above table shows the recommended sizes. This does not necessarily exclude the use of cylinders in other sizes.

Order Codes

CS — **KSHC** — — —

Clean room specification

Shock Absorbers Linear Orifice Type KSHC Series

Rod end type
Blank : No cap
C : With cap

Stopper nut
Blank : No stopper nut
S : With stopper nut^{Note}

Note: The stopper nut is an option available for models with cap (C) only.

Piston dia. X absorbing stroke	Maximum absorption
4×4	B : 0.3 J [0.22 ft·lbf] BD : 0.5 J [0.37 ft·lbf]
5×5	D : 1.0 J [0.74 ft·lbf] DE : 1.5 J [1.11 ft·lbf]
6×8	DE : 1.5 J [1.11 ft·lbf] EF : 2.5 J [1.84 ft·lbf]
8×8	EF : 2.5 J [1.84 ft·lbf] G : 4.0 J [2.95 ft·lbf]
9×10	GK : 5.0 J [3.69 ft·lbf] L : 8.0 J [5.90 ft·lbf]
11×15	M : 10 J [7.4 ft·lbf] P : 15 J [11.1 ft·lbf]
14×16	R : 20 J [14.8 ft·lbf] T : 30 J [22.1 ft·lbf]
18×25	X : 40 J [29.5 ft·lbf]

● Order codes for CS-KSHC5×5 thread size M8×1

CS-KSHC5×5 — — — **11**

Rod end type
Blank : No cap
C : With cap

Stopper nut
Blank : No stopper nut
S : With stopper nut^{Note}

Note: The stopper nut is an option available for models with cap (C) only.

Body thread size
11 : M8×1

Maximum absorption
D : 1.0 J [0.74 ft·lbf]
DE : 1.5 J [1.11 ft·lbf]

Additional Parts

● Stopper nut

S - KSH - M



Thread size

- 6 : M6×0.75 (for CS-KSHC4×4)
- 8 : M8×0.75 (for CS-KSHC5×5)
- 8-11 : M8×1 (for CS-KSHC5×5-11)
- 10 : M10×1 (for CS-KSHC6×8)
- 12 : M12×1 (for CS-KSHC8×8)
- 14 : M14×1.5 (for CS-KSHC9×10)
- 16 : M16×1.5 (for CS-KSHC11×15)
- 20 : M20×1.5 (for CS-KSHC14×16)
- 25 : M25×1.5 (for CS-KSHC18×25)

● Hexagon nut (10 nuts in one bag)

N - KSH - M



Thread size

- 6 : M6×0.75 (for CS-KSHC4×4)
- 8 : M8×0.75 (for CS-KSHC5×5)
- 8-11 : M8×1 (for CS-KSHC5×5-11)
- 10 : M10×1 (for CS-KSHC6×8)
- 12 : M12×1 (for CS-KSHC8×8)
- 14 : M14×1.5 (for CS-KSHC9×10)
- 16 : M16×1.5 (for CS-KSHC11×15)
- 20 : M20×1.5 (for CS-KSHC14×16)
- 25 : M25×1.5 (for CS-KSHC18×25)

Mass

Model	Body mass	Additional mass (options)	
		g [oz.]	
		Stopper nut ^{Note}	With cap
CS-KSHC4×4	4.8 [0.169]	2 [0.07]	0.1 [0.004]
CS-KSHC5×5	9.2 [0.325]	4 [0.14]	0.3 [0.011]
CS-KSHC6×8	21 [0.74]	7 [0.25]	1 [0.04]
CS-KSHC8×8	32 [1.13]	8 [0.28]	1 [0.04]
CS-KSHC9×10	58 [2.05]	15 [0.53]	2 [0.07]
CS-KSHC11×15	94 [3.32]	29 [1.02]	2 [0.07]
CS-KSHC14×16	172 [6.07]	50 [1.76]	3 [0.11]
CS-KSHC18×25	350 [12.35]	100 [3.53]	7 [0.25]

Note: The stopper nut is an option available for models with cap (C) only.

Calculation sample: The mass of CS-KSHC6×8 with cap and stopper nut is 21+1+7=29 g [1.02 oz.]

Inner Construction, Major Parts and Materials

- CS-KSHC4×4
- CS-KSHC5×5

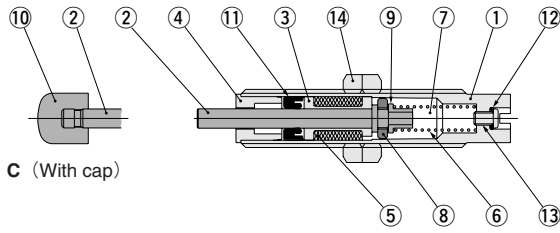

C (With cap)

- CS-KSHC6×8
- CS-KSHC8×8
- CS-KSHC9×10
- CS-KSHC11×15
- CS-KSHC14×16
- CS-KSHC18×25

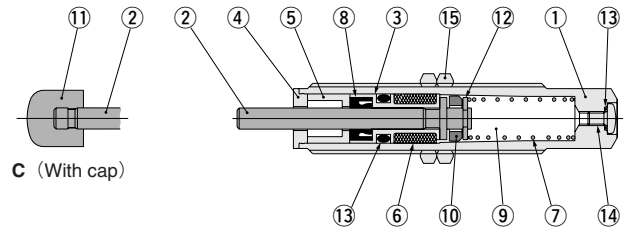

C (With cap)

Note : Part shapes vary somewhat between sizes.

- CS-KSHC4×4, 5×5

No.	Parts	Materials
①	Body	Copper alloy (nickel plated) [KSHC4: Steel (nickel plated)]
②	Piston rod	Steel (nickel plated)
③	Sleeve	Copper alloy
④	Plug	Stainless steel
⑤	Accumulator	Synthetic rubber (CR)
⑥	Spring	Spring steel
⑦	Oil	Special oil
⑧	Piston ring	Copper alloy
⑨	Collar	Copper alloy
⑩	Cap	Plastic (POM)
⑪	Rod seal	Synthetic rubber (NBR)
⑫	O-ring	Synthetic rubber (NBR)
⑬	Screw	Mild steel
⑭	Hexagon nut	Mild steel (nickel plated)

- CS-KSHC6×8, 8×8, 9×10, 11×15, 14×16, 18×25

No.	Parts	Materials
①	Body	Copper alloy (nickel plated)
②	Piston rod	Steel (nickel plated)
③	Sleeve	Copper alloy
④	Plug	Stainless steel
⑤	Spacer	Stainless steel
⑥	Accumulator	Synthetic rubber (CR)
⑦	Spring	Spring steel
⑧	Rod seal	Synthetic rubber (NBR)
⑨	Oil	Special oil
⑩	Piston ring	Copper alloy
⑪	Cap	Plastic (POM)
⑫	E-ring	Steel
⑬	O-ring	Synthetic rubber
⑭	Screw	Mild steel
⑮	Hexagon nut	Mild steel (nickel plated)

Dimensions mm [in.]

● No rod end cap: CS-KSHC4×4

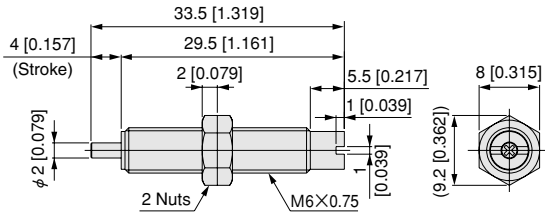

● With rod end cap: CS-KSHC4×4C

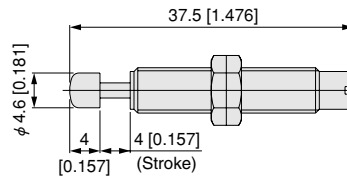

● No rod end cap: CS-KSHC5×5-11

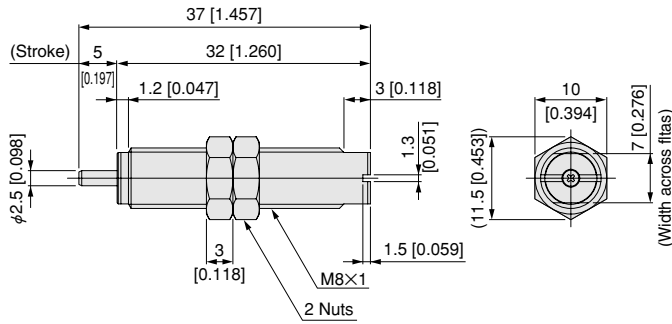

● With rod end cap: CS-KSHC5×5C-11

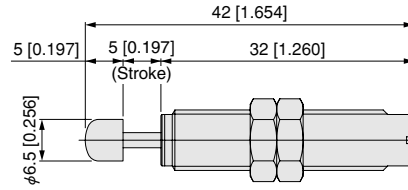

● No rod end cap: CS-KSHC□×□

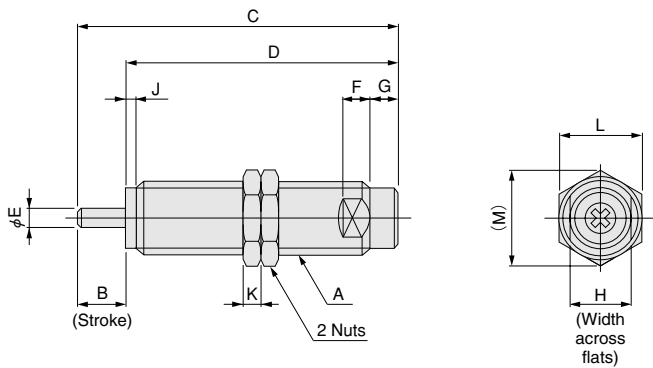

● With rod end cap: CS-KSHC□×□C

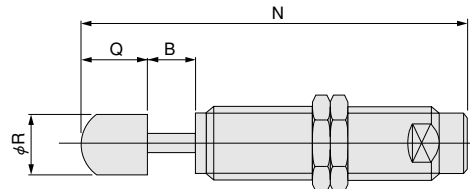

Model	Code	A	B	C	D	E	F	G	H	J	K	L	M	N	Q	R
CS-KSHC5×5□	M8×0.75	5 [0.197]	36 [1.417]	31 [1.220]	2.5 [0.098]	3 [0.118]	5 [0.197]	7 [0.276]	1.2 [0.047]	2 [0.079]	10 [0.394]	11.5 [0.453]	41 [1.614]	5 [0.197]	6.5 [0.256]	
CS-KSHC6×8□	M10×1	8 [0.315]	53 [2.087]	45 [1.772]	3 [0.118]	4 [0.157]	5 [0.197]	9 [0.354]	2 [0.079]	3 [0.118]	12 [0.472]	13.9 [0.547]	61 [2.402]	8 [0.315]	8 [0.315]	
CS-KSHC8×8□	M12×1	8 [0.315]	53 [2.087]	45 [1.772]	3 [0.118]	5 [0.197]	5.5 [0.217]	11 [0.433]	2 [0.079]	4 [0.157]	14 [0.551]	16.2 [0.638]	63 [2.480]	10 [0.394]	10 [0.394]	
CS-KSHC9×10□	M14×1.5	10 [0.394]	70 [2.756]	60 [2.362]	4 [0.157]	5 [0.197]	5.5 [0.217]	12 [0.472]	2 [0.079]	5 [0.197]	17 [0.669]	19.6 [0.772]	80 [3.150]	10 [0.394]	11 [0.433]	
CS-KSHC11×15□	M16×1.5	15 [0.591]	87 [3.425]	72 [2.835]	4 [0.157]	5 [0.197]	6 [0.236]	14 [0.551]	3 [0.118]	7 [0.276]	19 [0.748]	21.9 [0.862]	97 [3.819]	10 [0.394]	11 [0.433]	
CS-KSHC14×16□	M20×1.5	16 [0.630]	98 [3.858]	82 [3.228]	5 [0.197]	6 [0.236]	6 [0.236]	18 [0.709]	3 [0.118]	8 [0.315]	24 [0.945]	27.7 [1.091]	113 [4.449]	15 [0.591]	15 [0.591]	
CS-KSHC18×25□	M25×1.5	25 [0.984]	135 [5.315]	110 [4.331]	6 [0.236]	7 [0.276]	6 [0.236]	23 [0.906]	3 [0.118]	10 [0.394]	30 [1.181]	34.6 [1.362]	153 [6.024]	18 [0.709]	18 [0.709]	

Dimensions of Additional Parts mm [in.]

● Stopper nut: S-KSH-□-□ (-S)

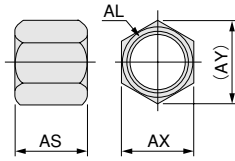

Model	Code	AL	AS	AX	AY
S-KSH-M6		M6×0.75	7 [0.276]	8 [0.315]	9.2 [0.362]
S-KSH-M8		M8×0.75	11 [0.433]	10 [0.394]	11.5 [0.453]
S-KSH-M8-11		M8×1	11 [0.433]	10 [0.394]	11.5 [0.453]
S-KSH-M10		M10×1	17 [0.669]	12 [0.472]	13.9 [0.547]
S-KSH-M12		M12×1	17 [0.669]	14 [0.551]	16.2 [0.638]
S-KSH-M14		M14×1.5	18 [0.709]	17 [0.669]	19.6 [0.772]
S-KSH-M16		M16×1.5	30 [1.181]	19 [0.748]	21.9 [0.862]
S-KSH-M20		M20×1.5	35 [1.378]	24 [0.945]	27.7 [1.091]
S-KSH-M25		M25×1.5	40 [1.575]	30 [1.181]	34.6 [1.362]

● Hexagon nut: N-KSH-□-□

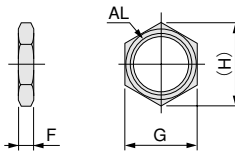

Model	Code	AL	F	G	H
N-KSH-M6		M6×0.75	2 [0.079]	8 [0.315]	9.2 [0.362]
N-KSH-M8		M8×0.75	2 [0.079]	10 [0.394]	11.5 [0.453]
N-KSH-M8-11		M8×1	3 [0.118]	10 [0.394]	11.5 [0.453]
N-KSH-M10		M10×1	3 [0.118]	12 [0.472]	13.9 [0.547]
N-KSH-M12		M12×1	4 [0.157]	14 [0.551]	16.2 [0.638]
N-KSH-M14		M14×1.5	5 [0.197]	17 [0.669]	19.6 [0.772]
N-KSH-M16		M16×1.5	7 [0.276]	19 [0.748]	21.9 [0.862]
N-KSH-M20		M20×1.5	8 [0.315]	24 [0.945]	27.7 [1.091]
N-KSH-M25		M25×1.5	10 [0.394]	30 [1.181]	34.6 [1.362]

Evaluation of Cleanliness (Shock Absorber KSHC Series)

There is currently no standard in JIS or elsewhere for methods of evaluating shock absorber's cleanliness. Koganei has therefore independently established our in-house measurement methods, to conduct the cleanliness evaluations.

● Measurement method

1. Measure particles in the clean bench (Figure 1) without activating the measurement use shock absorber and load driving cylinder in the clean bench (to measure the background valve).^{Note}

Note : Under the background measurement condition, the number of particles measures zero.

2. Drive the load and activate the shock absorber under the measurement condition, to measure the particles.

● Measurement conditions

- Load impact speed : 300 mm/s [11.8 in./sec.]
- Shock absorber operating frequency : 30 cycle/min^{Note 1}
- Particle measurement time : 1 minute
- Suction rate : 1 cf/min
- Measured particles : 0.1 μm and larger

For reference, a graph of actual values is shown in Figure 2.

The number of particles is the average value of the test samples. Also, the smaller the angle variation of eccentricity when mounting the shock absorber, the lower the number of particles is likely to be. Mount the shock absorber so that its angle of eccentricity to the workpiece is as small as possible.

- Notes: 1. The number of particles is based on 30 operation cycles. The customer's evaluation should be based on the customer's own operation frequency.
 2. Corresponds to FED-STD Class1.
 3. The number of particles in the graph are actual values measured under Koganei standards, and are not intended to be guaranteed values.

● Outline of particle measuring device

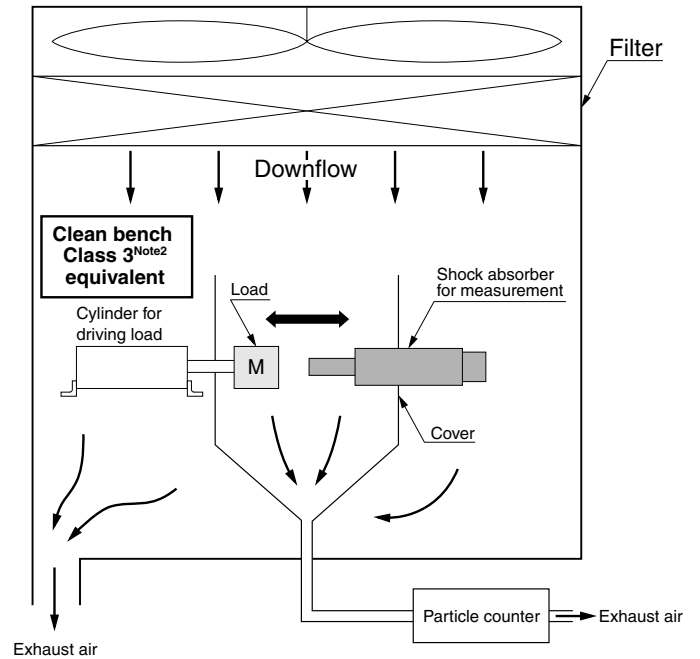

Figure 1

● Number of particles (measured value) ^{Note 3}

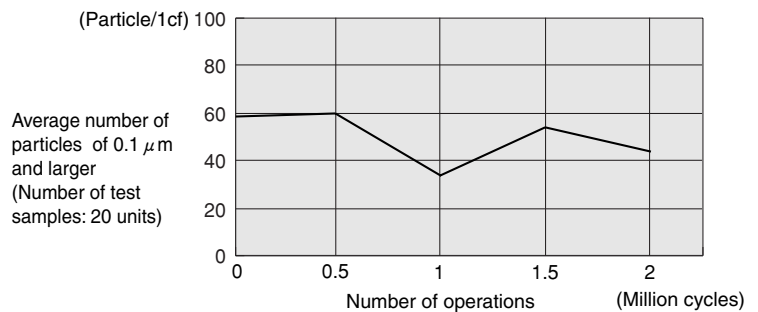

Figure 2

SHOCK ABSORBERS

ADJUSTABLE ABSORPTION CAPACITY TYPE

KSHE, KSH Series

Specifications

Item	Model	Multi orifice type					Single orifice type				
		KSHE5×8	KSHE6×10	KSHE8×15	KSHE10×20	KSHE12×22	KSH5×8	KSH6×10	KSH8×10	KSH10×15	KSH12×22
Maximum absorption J [ft·lbf]		1.5 [1.11]	3.0 [2.21]	9.8 [7.23]	14.7 [10.84]	29.4 [21.69]	1.5 [1.11]	3.0 [2.21]	5.9 [4.35]	9.8 [7.23]	24.5 [18.07]
Absorbing stroke mm [in.]		8 [0.31]	10 [0.39]	15 [0.59]	20 [0.79]	22 [0.87]	8 [0.31]	10 [0.39]	10 [0.39]	15 [0.59]	22 [0.87]
Maximum impact speed m/s [ft./sec.]		1.5 [4.92]					1.0 [3.28]				
Maximum operating frequency cycle/min		60					30				
Spring return force ^{Note} N [lbf.]		5.6 [1.26]	9.2 [2.07]	10.7 [2.41]	14.4 [3.24]	16.3 [3.66]	5.6 [1.26]	9.2 [2.07]	15.7 [3.53]	16.6 [3.73]	37.1 [8.34]
Angle variation		3° or less					3° or less				
Operating temperature range °C [°F]		0~60 [32~140]					0~60 [32~140]				

Note: Values when compressed.

Mass

Model	Item	Body Mass	Additional mass			
			Side mounting bracket	Flange mounting bracket	Stopper nut	With cap
KSHE5×8	KSH5×8	24 [0.85]	15 [0.53]	16 [0.56]	7 [0.25]	1 [0.035]
KSHE6×10	KSH6×10	43 [1.52]	22 [0.78]	15 [0.53]	8 [0.28] (12 [0.42])	1 [0.035]
		90 [3.17]			19 [0.67] (30 [1.06])	
KSHE8×15	KSH8×10	102 [3.60]	68 [2.40]	28 [0.99]	34 [1.20] (50 [1.76])	4 [0.14]
		130 [4.59]			4 [0.14]	
KSHE10×20	KSH10×15	144 [5.08]	110 [3.88]	57 [2.01]	46 [1.62] (69 [2.43])	8 [0.28]
		192 [6.77]			8 [0.28]	
KSHE12×22	KSH12×22	200 [7.05]	140 [4.94]	54 [1.90]	46 [1.62] (69 [2.43])	8 [0.28]
		200 [7.05]			8 [0.28]	

Note: Values in parentheses () are for with cap models.

Remarks : 1. The body is equipped with two mounting nuts.

2. For side mounting bracket, supplied with two mounting screws.

Calculation sample: The mass of KSHE10×20 with side mounting bracket, stopper nut and cap is
144+110+50+5=309 g [10.90 oz.]

Order Codes

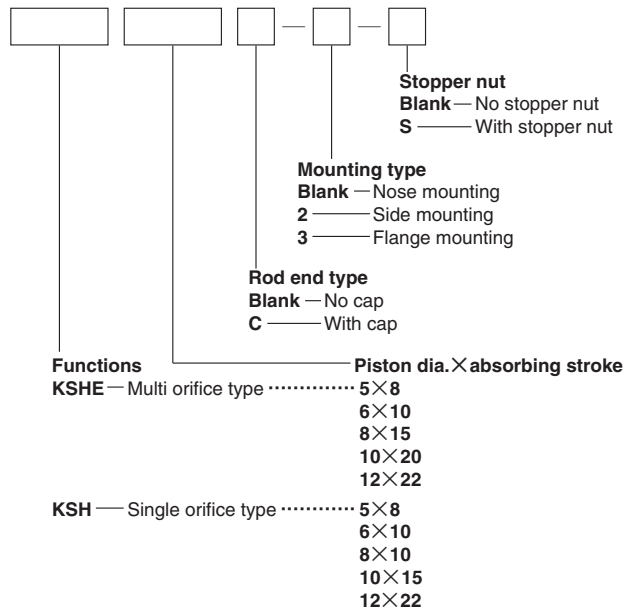

- Mounting bracket and stopper nut are included at time of delivery.
- The mounting screws are included with the side mounting bracket.
- Stopper nut dimensions differ between with rod end cap and no cap type.

Inner Construction and Major Parts

The illustration shows multi orifice type : For KSHE□×□.

Not in operation

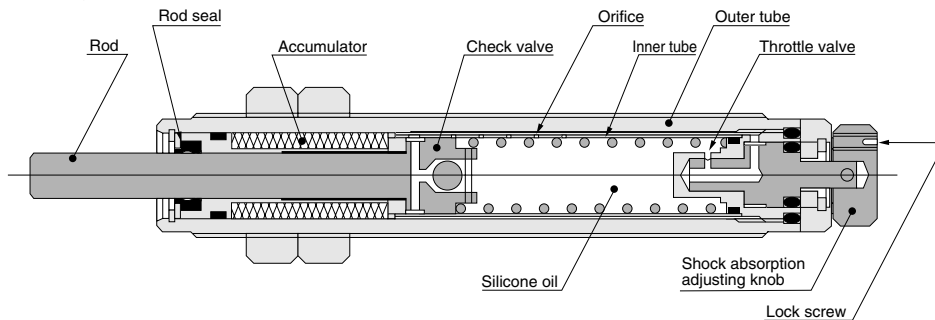

In operation

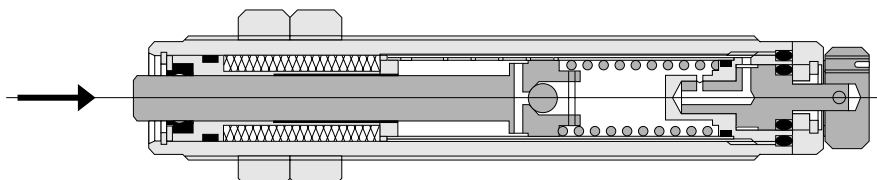

Selection Guideline

Precautions for Use of Selection Graphs

1. The selection graphs show the best conditions for usage of the product with horizontal impacts.
2. The selection graphs are calculated for a cylinder with air pressure of 0.5 MPa [73 psi].

● Selection Graphs

KSH (For low speed)

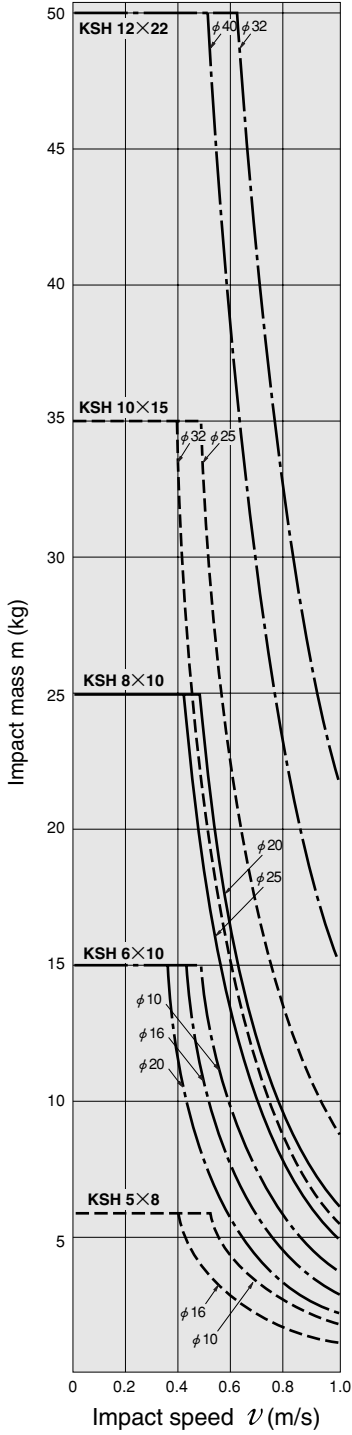

KSHE (For high speed)

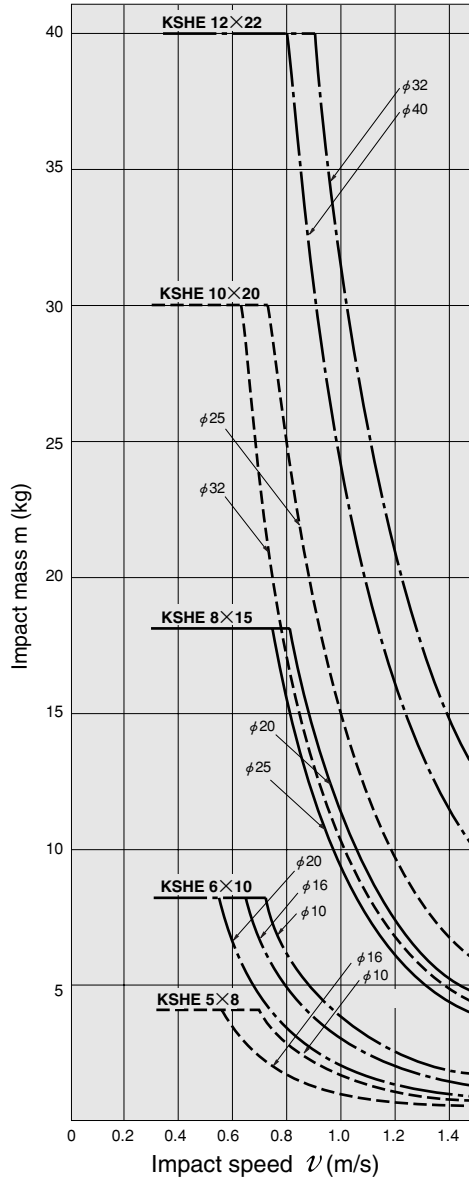

1 kg = 2.20 lb. 1 m/s = 3.28 ft./sec.

Dimensions (mm)

● Nose mounting

● No rod end cap
KSHE□×□, KSH□×□



KSH Piston dia. × absorbing stroke

● With rod end cap
KSHE□×8C

KSHE5×8C
KSH□×□C



S-CAP

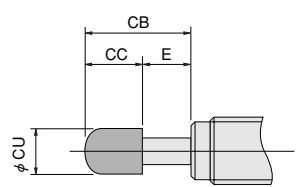
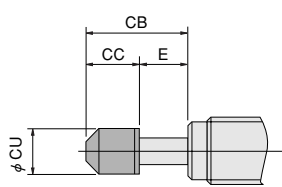
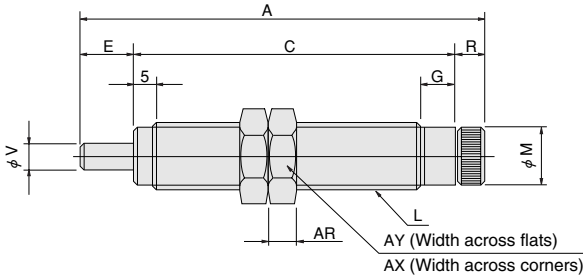

Model	Code	A	C	E	G	L	M	R	V	AR	AX	AY	CB	CC	CU
KSHE5×8□	KSH5×8□	68	55	8	4	M10×1	9	5	3	3	13.9	12	16	8	8
KSHE6×10□	KSH6×10□	78	61	10	10	M12×1	11	7	3	4	16.2	14	20	10	10
	KSH8×10□	92	75	10	10	M16×1.5	13	7	5	7	21.9	19	25	15	12
KSHE8×15□	KSH10×15□	101.5	79.5	15	10	M16×1.5	13	7	5	7	21.9	19	30.5	15.5	13
	KSH10×15□	114	92	15	10	M18×1.5	15	7	6	8	25.4	22	30	15	14
KSHE10×20□		115	88	20	10	M18×1.5	15	7	5	8	25.4	22	35.5	15.5	15
KSHE12×22□		120	91	22	10	M20×1.5	17	7	5	10	27.7	24	40	18	16
	KSH12×22□	147	118	22	10	M20×1.5	17	7	6	10	27.7	24	40	18	16

Dimensions of Mounting Bracket (mm)

● Side mounting bracket : -2



S-SIDE

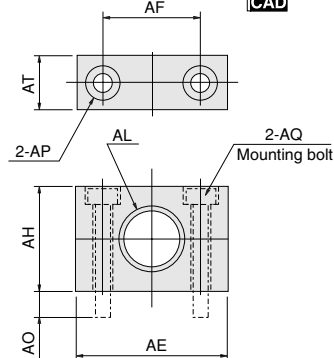

Model	Code	AE	AF	AH	AL	AO
For KSHE 5×8□	For KSH 5×8□	22	14	14	M10×1 Counterbore φ 10.2 Depth2	(9.3)
For KSHE 6×10□	For KSH 6×10□	25	16	18	M12×1 Counterbore φ 12.2 Depth2	(5.3)
For KSHE(S) 8×15□ ^{Note}	For KSH 8×10□	38	25	25	M16×1.5	(7.4)
For KSHE(S) 10×20□ ^{Note}	For KSH10×15□	50	34	30	M18×1.5	(11.5)
For KSHE(S) 12×22□ ^{Note}	For KSH12×22□	50	34	30	M20×1.5	(13.6)

Model	Code	AP	AQ (Hexagon socket head screw)	AT
For KSHE 5×8□	For KSH 5×8□	φ 3.4 Counterbore φ 6.2 Depth3.3	M3×0.5 Screw length 20	9
For KSHE 6×10□	For KSH 6×10□	φ 3.4 Counterbore φ 6.2 Depth3.3	M3×0.5 Screw length 20	9
For KSHE(S) 8×15□ ^{Note}	For KSH 8×10□	φ 4.5 Counterbore φ 8 Depth4.4	M4×0.7 Screw length 28	12
For KSHE(S) 10×20□ ^{Note}	For KSH10×15□	φ 6.5 Counterbore φ 11 Depth6.5	M6×1 Screw length 35	12
For KSHE(S) 12×22□ ^{Note}	For KSH12×22□	φ 9 Counterbore φ 14 Depth8.6	M8×1.25 Screw length 35	16

● Mounting screws (hexagon socket head screws) are supplied with side mounting bracket.
Note: For KSHES (shock absorbers with sensor switch), see p.595.

● Flange mounting bracket : -3



S-FLANGE

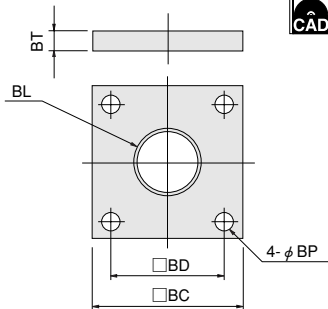

Model	Code	BC	BD	BL	BP	BT
For KSHE 5×8□	For KSH 5×8□	25	18	M10×1 Counterbore φ 10.2 Depth1.7	3.2	4
For KSHE 6×10□	For KSH 6×10□	25	18	M12×1 Counterbore φ 12.2 Depth1.7	3.2	4
For KSHE(S) 8×15□ ^{Note}	For KSH 8×10□	34	24	M16×1.5	4.5	4
For KSHE(S) 10×20□ ^{Note}	For KSH10×15□	40	28	M18×1.5	6.5	6
For KSHE(S) 12×22□ ^{Note}	For KSH12×22□	40	28	M20×1.5	6.5	6

Note: For KSHES (shock absorbers with sensor switch), see p.595.

● Stopper nut : -S



S-STOPER

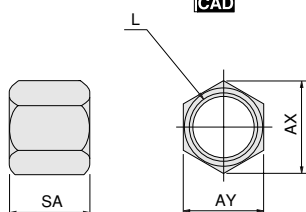

Model	Code	L	AX	AY	SA
For KSHE 5×8	For KSH 5×8	M10×1	13.9	12	17
For KSHE 5×8C	For KSH 5×8C				17
For KSHE 6×10	For KSH 6×10	M12×1	16.2	14	25
For KSHE 6×10C	For KSH 6×10C				20
For KSHE 8×15	For KSH 8×10	M16×1.5	21.9	19	32
For KSHE 8×15C	For KSH 8×10C				25
For KSHE10×20	For KSH10×15	M18×1.5	25.4	22	37
For KSHE10×20C	For KSH10×15C				30
For KSHE12×22	For KSH12×22	M20×1.5	27.7	24	45
For KSHE12×22C	For KSH12×22C				

SHOCK ABSORBERS WITH SENSOR SWITCH ADJUSTABLE ABSORPTION CAPACITY TYPE

KSHES Series

Specifications

Item	Model	KSHES8×15	KSHES10×20	KSHES12×22
Maximum absorption	J [ft·lbf]	9.8 [7.23]	14.7 [10.84]	29.4 [21.69]
Absorbing stroke	mm [in.]	14.5 [0.571]	19.5 [0.768]	21.5 [0.846]
Maximum impact speed	m/s [ft./sec.]	1.5 [4.92]		
Maximum operating frequency	cycle/min	60		
Spring return force ^{Note}	N [lbf.]	10.7 [2.41]	14.4 [3.24]	16.3 [3.66]
Angle variation		3° or less		
Operating temperature range	°C [°F]	0~60 [32~140]		

Note: Values when compressed.

Mass

Model	Body Mass	Additional mass									
		Holder		Mounting bracket		Sensor switch					
		-H (Without stopper)	-HS (Stopper type)	-2 (Side mounting)	-3 (Flange mounting)	ZC130	ZC153	CS5T	CS11T		
KSHES 8×15	108 [3.81]	18 [0.63]	44 [1.55]	68 [2.40]	28 [0.99]						
KSHES10×20	153 [5.40]	22 [0.78]	49 [1.73]	110 [3.88]	57 [2.01]	20 ^{Note} [0.71]	20 ^{Note} [0.71]	20 ^{Note} [0.71]	20 ^{Note} [0.71]		
KSHES12×22	203 [7.16]	25 [0.88]	57 [2.01]	140 [4.94]	54 [1.90]						

Note: For lead wire length 1000mm [39in.].

Remarks: 1. Two mounting nuts are supplied with a shock absorber body.

2. One mounting nut is supplied with a holder.

3. Two mounting screws are supplied with a side mounting bracket.

Calculation sample: The mass of KSHES10×20 with a holder (-HS), side mounting bracket (-2), and sensor switch is 153+49+110+20=332 g [11.71 oz.]

Order Codes

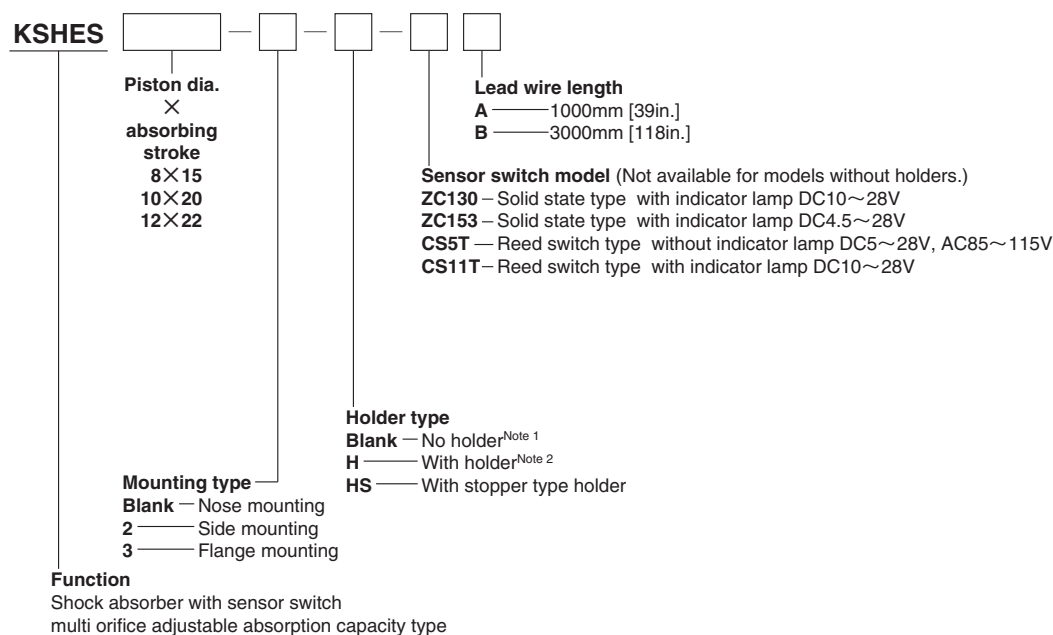

Orders for holders and sensor switches only

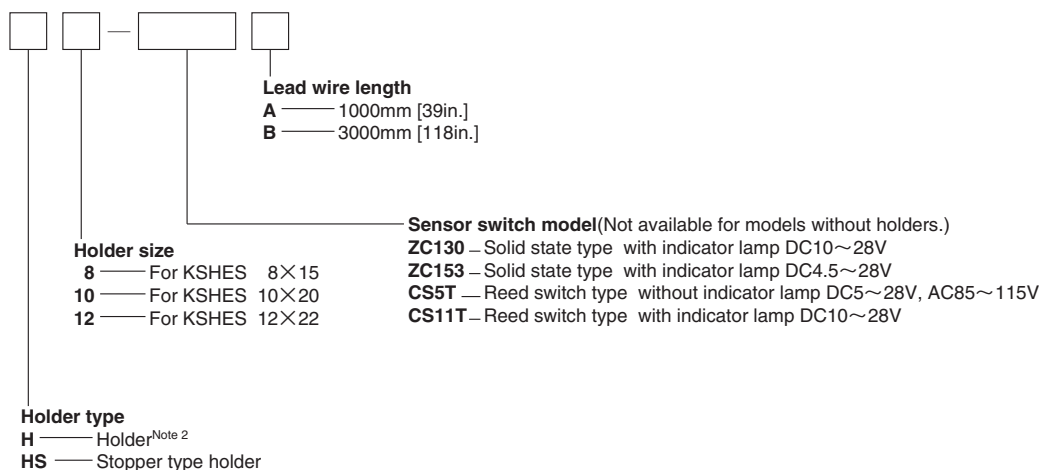

Notes: 1. Sensor switch is not included in the models without holders.

2. Cannot be used as a stopper.

Inner Construction and Major Parts

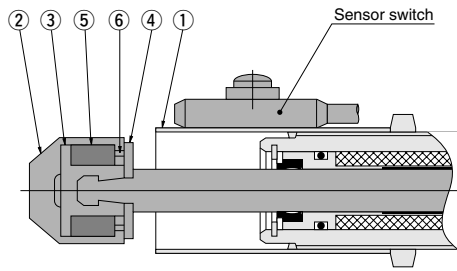

Major Parts and Materials

No.	Parts	Materials	
①	Holder	-H	Aluminum (black anodized)
		-HS	Stainless steel (no surface treatment)
②	Rubber cap	Urethane rubber	
③	Cap	Polyacetal	
④	Washer	Stainless steel	
⑤	Magnet	Rare earth magnet	
⑥	Magnet support	Polyacetal	

Dimensions (mm)

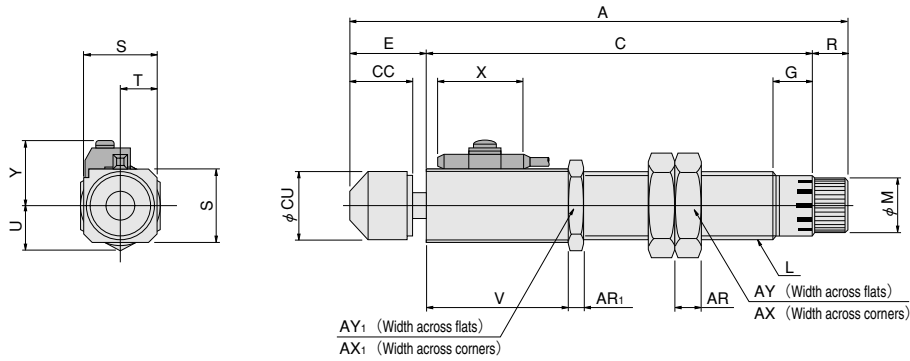

Code	A	C	E	G	L	M	R	S	T	U	V	X				Y	AR	AR ₁	AY	AY ₁	AX	AX ₁	CC	CU
												ZC130□	ZC153□	CS5T□	CS11T□									
KSHES 8×15	117.5	96	14.5	10	M16×1.5	13	7	19	9.5	10	33					17.5	7	4	19	19	21.9	21.9	(15.5)	14
KSHES10×20	130.5	104	19.5	10	M18×1.5	15	7	20	10	10	36	25	25	22	26	18.5	8	6	22	22	25.4	25.4	15.5	16
KSHES12×22	138.5	110	21.5	10	M20×1.5	17	7	22	11	11	37					19.5	10	6	24	24	27.7	27.7	18	18

● For mounting bracket dimensions, see p.594.

Mounting Position for Holders and Sensor Switches

When the sensor switch is mounted in the position in the diagram (the figures in the tables are reference values), the magnet comes to the maximum sensing position of the sensor switch at the end of stroke .

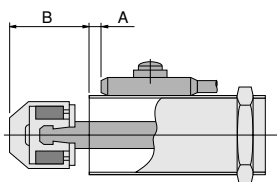

Shock absorber Model	A Note				B
	Sensor switch model				
	ZC130□	ZC153□	CS5T□	CS11T□	
KSHES 8×15	1.5	1.5	3	1	14.5 ^{+0.3} ₀
KSHES10×20	1.5	1.5	3	1	19.5 ^{+0.3} ₀
KSHES12×22	4.0	4.0	5.5	2	21.5 ^{+0.3} ₀

Note: Mount the sensor switch so that it does not protrude from the holder.

- Cautions:**
1. The sensitivity of the sensor switch can vary depending on the environment. If operation appears unstable, relocate the sensor switch to an optimum location, and use a set-screw to secure it in place.
 2. Mount so that the sensor switch's order code is displayed on top.

Moving Sensor Switch

- Loosening the sensor switch set-screw allows the sensor switch to be moved along the axis direction of the shock absorber.
- Do not exceed a tightening torque of the set-screw 19.6N·cm [1.73in·lbf].

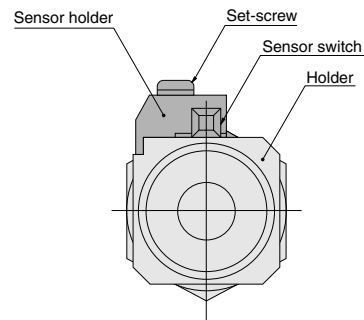

SHOCK ABSORBERS

Optional Shock Absorbers for Particular Products

● Shock Absorbers for AXIS Cylinders

Specifications

Item \ Model	KSHAX6×5	KSHAX7×5	KSHAX8×6	KSHAX10×8	KSHAX12×10
Applicable cylinder	XDA□16	XDA□20	XDA□25	XDA□32	XDA□40
Maximum absorption J [ft·lbf]	1.5 [1.11]	2.0 [1.48]	2.9 [2.14]	6.9 [5.09]	11.8 [8.70]
Absorbing stroke mm [in.]	5 [0.20]	5 [0.20]	6 [0.24]	8 [0.31]	10 [0.39]
Maximum impact speed mm/s [ft./sec.]	700 [2.3]				
Maximum operating frequency cycle/min	60				
Operating temperature range °C [°F]	0~60 [32~140]				
Mass kg [oz.]	0.018 [0.63]	0.033 [1.16]	0.045 [1.59]	0.084 [2.96]	0.107 [3.77]

Order Codes

KSHAX



Piston dia. × absorbing stroke

6×5
7×5
8×6
10×8
12×8

Shock absorber for AXIS cylinder

Dimensions (mm)

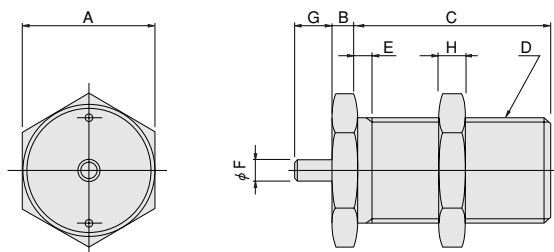

Code \ Model	A	B	C	D	E	F	G (Stroke)	H
KSHAX6×5	14	3	19	M12×1	1.5	3	5	3
KSHAX7×5	17	3	26	M14×1	2	3	5	4
KSHAX8×6	19	3	28	M16×1.5	2	3	6	4
KSHAX10×8	22	3	37	M20×1.5	2	5	8	4
KSHAX12×10	24	3	40	M22×1.5	2	5	10	4

Caution: For AXIS Cylinders, see the Actuators General Catalog.

● Shock Absorbers for Magnet Type Rodless Cylinders MRG

Specifications

Item	Model	KSHDM 5×6	KSHDM 5×8	KSHDM 5×10	KSHDM 6×10	KSHDM 8×12	KSHDM 10×15	KSHDM 12×18
Applicable cylinder		MRGH6	MRGH10	MRG□16	MRG□20	MRG□25	MRG□32	MRG□40
Maximum absorption	J [ft·lbf]	0.5 [0.37]	1.0 [0.74]	2.5 [1.84]	3.9 [2.88]	5.9 [4.35]	13.3 [9.81]	26.5 [19.55]
Absorbing stroke	mm [in.]	6 [0.24]	8 [0.31]	10 [0.39]	10 [0.39]	12 [0.47]	15 [0.59]	18 [0.71]
Maximum impact speed	mm/s [ft./sec.]	800 [2.6]						
Maximum operating frequency	cycle/min	60						
Spring return force ^{Note}	N [lbf.]	4.9 [1.10]	7.8 [1.75]	6.9 [1.55]	6.9 [1.55]	19.6 [4.41]	14.7 [3.30]	16.7 [3.75]
Angle variation		2° or less						
Operating temperature range	°C [°F]	0~60 [32~140]						

Note: Values when compressed.

Order Codes

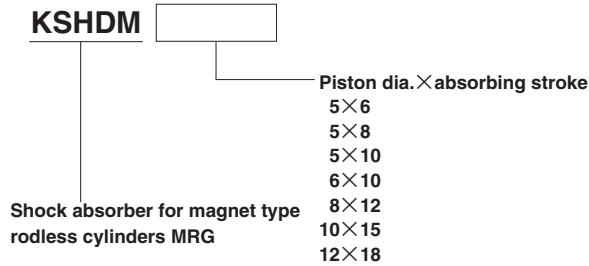

Dimensions (mm)

Note: The mounting nut is also used for a stopper bolt.

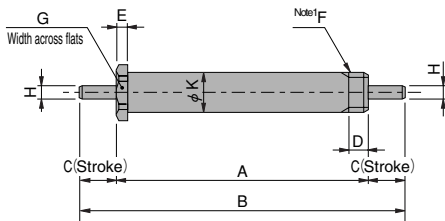

Model	Code	A	B	C	D	F	G	H	K	E
KSHDM5×6		46	58	6	5	M8×1	12	2.5	8 ^{-0.03} _{-0.17}	2.8
KSHDM5×8		51	67	8	5	M10×1	14	3	10 ^{-0.03} _{-0.18}	2.8
KSHDM5×10		66	86	10	5	M10×1	14	3	10 ^{-0.03} _{-0.18}	2.8
KSHDM6×10		73	93	10	7	M12×1	17	3	12 ^{-0.04} _{-0.19}	3.8
KSHDM8×12		80	104	12	8	M14×1.5	19	5	14 ^{-0.04} _{-0.21}	4.8
KSHDM10×15		99	129	15	10	M18×1.5	22	5	18 ^{-0.05} _{-0.22}	6.8
KSHDM12×18		109	145	18	10	M20×1.5	24	5	20 ^{-0.05} _{-0.22}	6.8

Note: The mounting nut is not supplied. Use the mounting nut for MRG's stopper bolt.

Caution: For Magnet Type Rodless Cylinders MRG series, see the Actuators General Catalog.

● Shock Absorbers for Systematic Handling Modules SHM Series

Specifications

Item	Model	KSHAH6×3	KSHAH6×4	KSHAH6×5
Maximum absorption	J [ft·lbf]	0.3 [0.22]	0.9 [0.66]	1.4 [1.03]
Operating angle variation range		10°	20°	25°
Maximum impact speed	m/s [ft./sec.]	0.1 [0.33]		
Maximum operating frequency	cycle/min	60		
Absorbing stroke	mm [in.]	3 [0.12]	4 [0.16]	5 [0.20]
Operating temperature range	°C [°F]	0~60 [32~140]		
Mass	g [oz.]	14 [0.49]	18 [0.63]	22 [0.78]

Order Codes

KSHAH

Piston dia.×absorbing stroke
 6×3
 6×4
 6×5

Shock absorber for systematic handling modules SHM series reverse module

Caution: For Systematic Handling Modules SHM series, see the Actuators General Catalog.

Dimensions (mm)

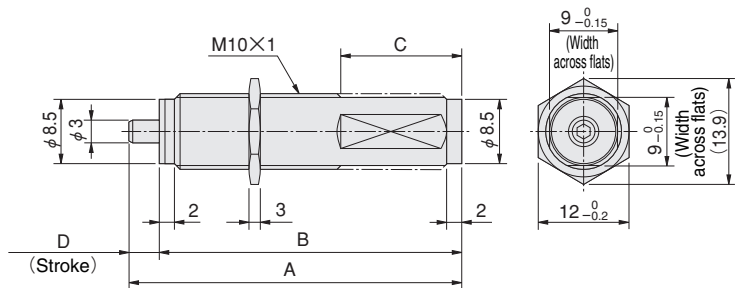

Model	A	B	C	D
KSHAH6×3	33	30	16	3
KSHAH6×4	44	40		4
KSHAH6×5	53	48	22	5

● Shock Absorbers for Rotary Actuators RAT Series

Specifications

Item	Model	KSHAR5×5-D	KSHAR5×5-E	KSHAR6×8-F
Applicable actuator		RAT5	RAT10	RAT30
Maximum absorption	J [ft·lbf]	1.0 [0.74]	2.0 [1.48]	3.0 [2.21]
Absorbing stroke	mm [in.]	5 [0.20]		8 [0.31]
Maximum operating frequency	cycle/min	60		30
Maximum impact speed	mm/s [ft./sec.]	300 [0.98]		
Angle variation		8° or less		12° or less
Operating temperature range	°C [°F]	0~60 [32~140]		

Note: While staying within the range of shock absorption capacity, also keep the swing time adjustment range and allowable energy of Rotary Actuators RAT series.

Remarks: 1. Do not loosen or remove the small screw on the rear end of the shock absorber. The oil contained inside could leak out, damaging shock absorber's functions.

2. Depending on operating conditions, the durability may vary from Rotary Actuators RAT series.

Order Codes

KSHAR

- 5×5-D : For RAT5-□
- 5×5-E : For RAT10-□
- 6×8-F : For RAT30-□

Shock absorber for rotary actuators RAT series

Remark: The shock absorber and rubber stopper also include one nut each for securing to the main body.

Dimensions (mm)

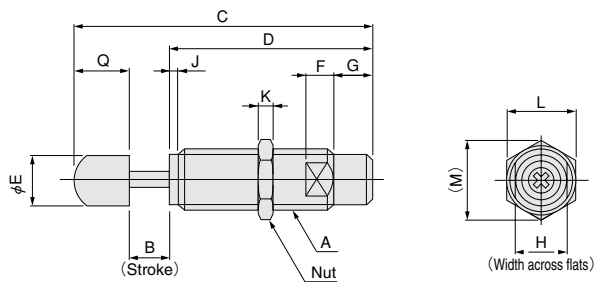

Model	A	B	C	D	E	F	G	H	J	K	L	M	Q
KSHAR5×5-D	M8×0.75	5	46	31	6	3	5	7	1.2	2	10	11.5	10
KSHAR5×5-E	M8×0.75	5	46	31	6	3	5	7	1.2	2	10	11.5	10
KSHAR6×8-F	M10×1	8	61	45	8	4	5	9	2	3	12	13.9	8

Caution: For Rotary Actuators RAT series, see the Actuators General Catalog.

