

ROTARY PADDLE TYPE LEVEL SWITCH

Model **NL/NM/FL-GM/NNL/NNM**
SERIES

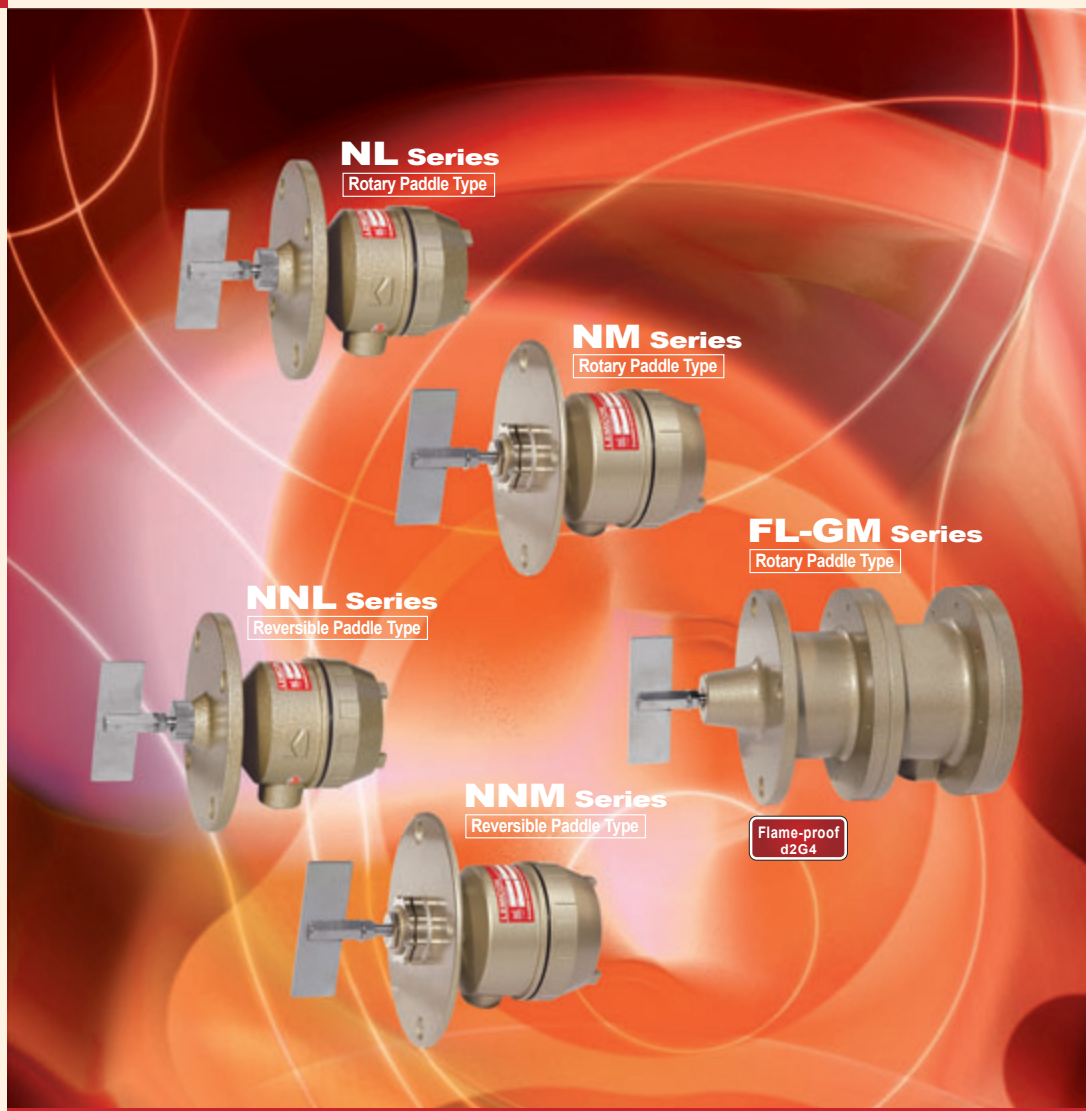

Uncomparable models developed based on our abundant technology experiences and long-term achievements in the market. A variety of products are lined up. We assure that you will be able to find an optimum model.

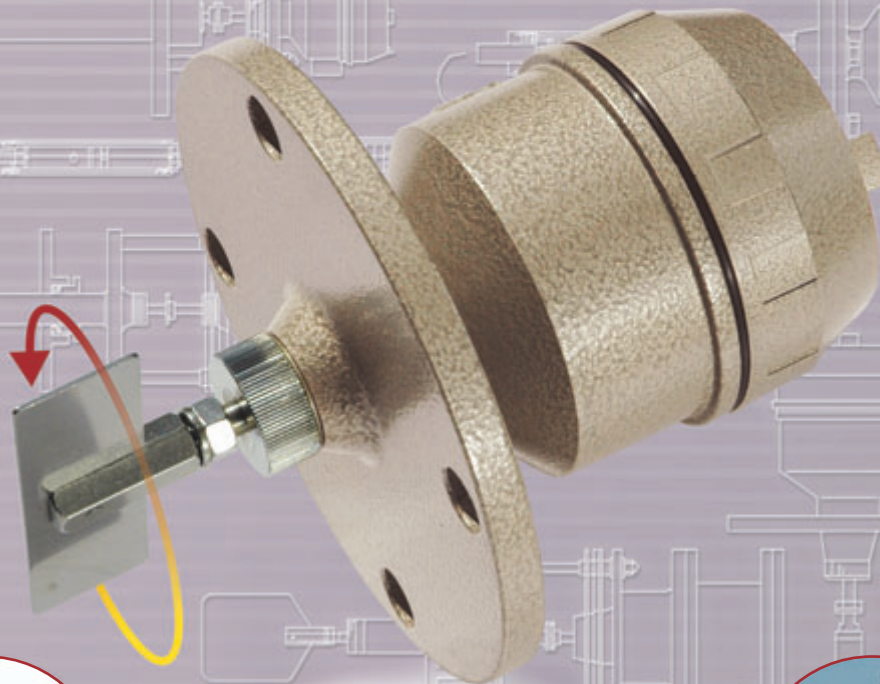

ROTARY PADDLE TYPE LEVEL SWITCH

Level Switch you can use in versatile applications, exclusively for powders.

As it is easy to handle, it operates stably for a long period of time. It is a best selling line for having gained customers confidence and expanded sales record in the market.



NL Series
Standard type for detecting powder, versatile usages.



NNL Series
The original switching system enables the amazing long life of the motor.



NM Series
Cost effective, standard type with no excessive functions.

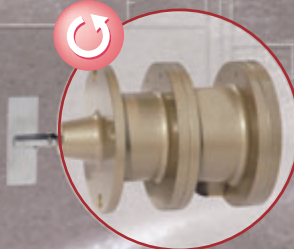

FL-GM Series
Various models of Explosion-proof Type.

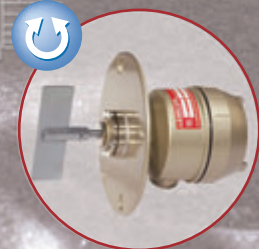

NNM Series
Reversible Type, Highly cost effective.

Flame-proof
d2G4

**A standard model of rotary type level switch that continuously keeps evolving.
Covering a wide range of applications with various models.**

**Rotary Paddle Type
NL/NM
Series**

- You may easily adjust torque when taking off the Lid.
- It prevents powder from intruding from the axis with oilseal and thrust-teflon packing.
- The clutch system helps prevent the motor from being broken even when the paddle is overloaded.

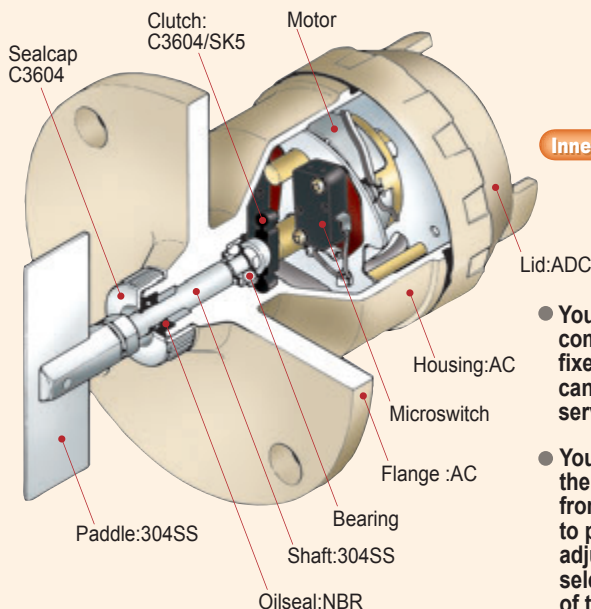

Inner Structure

- You may take off interior components as it remains fixed on a tank, and you can easily inspect and service it.
- You may reliably detect the measuring substance from hypobaric powder to particles with no sensitivity adjustment only if you select the appropriate size of the paddle.

Principle Of Operation

A rotating paddle, being loaded by sediments in a tank, activates a limit switch and brings contact output and motor rotation to a halt at the same time. With no load by sediments, the motor resumes rotation. When the paddle is overloaded or suffers strong shock, a clutch system prevents the motor from being broken by letting out excessive load and shock.

Inner Components

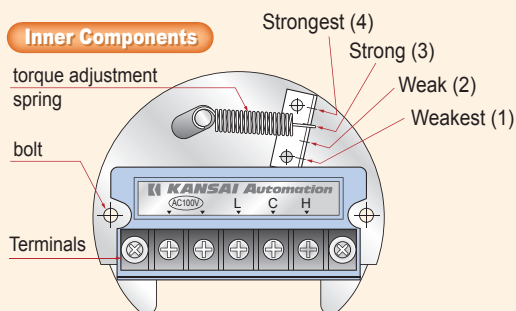

*Shipped from factory in weak torque.
*Inner structure of FL types is different.

Standard Specification

- Power Source : 100–110VAC or 200–220VAC 50/60Hz
- Power Consumption : 4W
- Contact Capacity : 250VAC 5A Resistance Load
- Rate of Rotation : 1 r.p.m/50Hz
- Allowable Temperature : below 50°C (in a tank)
- Withstand Voltage : 1500VAC one minute for in between terminal and housing
- Detection Torque : $1470-1764N \cdot m \times 10^{-4}$
- Allowable Pressure : 19.6kPa
- Color : Gold
- Process Connection : G1B or Equivalent to JIS 5K 65A
- Enclosure Rating : IP55 or equivalent

Wiring Diagram

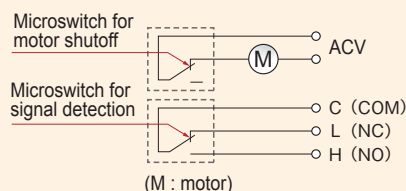

24VDC Power Adaptive

An AC motor model has had an excellent sales record for a long period of time since the introduction into the market, and it, its electromechanical components remaining unremoved, is replaced with DC motor, which makes Rotary Type Level Switch of DC type, featured by stable and reliable rotations. Because the electronic components are surface mounted, vibration resistance is upgraded.

Standard Specification

- Power Source : 24VDC ±1V
- Power Consumption : 5W
- Contact Capacity : 30VDC 100mA Resistance Load
- Rate of Rotation : 1.25r.p.m

*Allowable temperature and pressure, detection torque and so on are the same as those of NL & NM.

Wiring Diagram

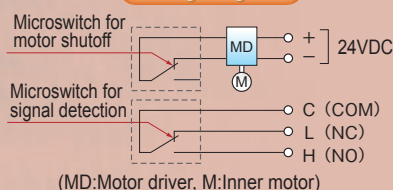

Rotary Paddle Type model **NL**

The basic model of Rotary Type Level Switch that can be applied to all and every conditions.

(Wetted parts can be made of 304SS or 316SS)

Standard Flange Type **NL-8B**

The NL basic model, suitable for powders not much sticking to the tank wall.

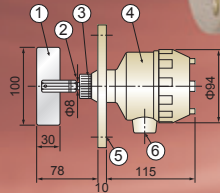
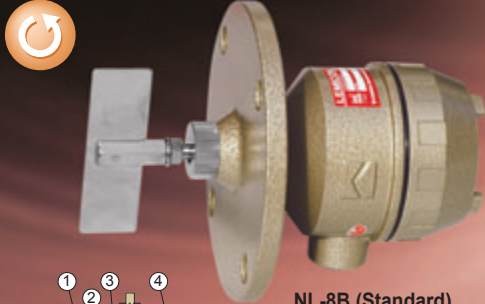

NL-8B (Standard)

1	Paddle	304SS
2	Main Shaft	304SS
3	Sealcap	C3604
4	Housing	AC
5	Flange	AC
6	Conduit Connection	G 1/2

- Flange size: JIS5K65A equivalent
- L Dimension below flange can be extended up to 200mm.
- Weight: about 1.65kg

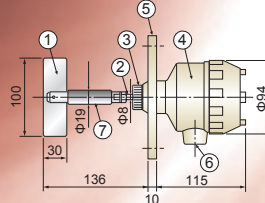

NL-8BF (Flexible shaft)

1	Paddle	304SS
2	Main Shaft	304SS
3	Sealcap	C3604
4	Housing	AC
5	Flange	AC
6	Conduit Connection	G 1/2
7	Flexible Shaft	—

●Flange size: JIS5K65A equivalent

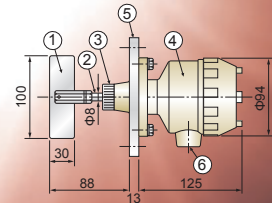
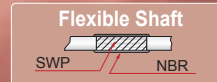

NL-8B (Wetted part SUS)

1	Paddle	304SS
2	Main Shaft	304SS
3	Sealcap	304SS
4	Housing	AC
5	Flange	304SS
6	Conduit Connection	G 1/2

●Flange size: JIS5K65A equivalent

Adjustable Shaft Type **NL-8BA**

The shaft can be adjustable to the selective length with fixing nuts. Even if the repose angle is not available, in advance it can optimally be adjusted on site.

*Upper Limit detection type

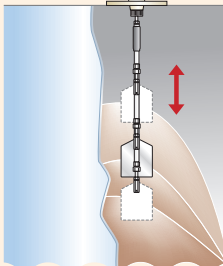
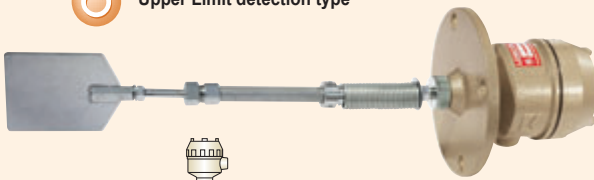

- Flange Size: JIS5K65A equivalent
- Vertical mounting
- The shaft is protected with a universal joint.
- The shaft can be adjustable to the selective length with fixing nuts.
- Heat resistant type can be available.

NL-8BA (Reinforcing spring)

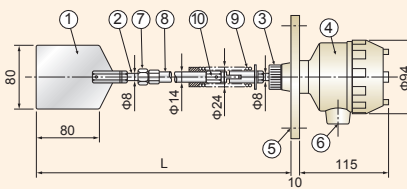

1	Paddle	304SS
2	Main Shaft	304SS
3	Sealcap	C3604
4	Housing	AC
5	Flange	AC
6	Conduit Connection	G 1/2
7	Lock Nut	C3604
8	Protective Tube	SGP
9	Spring	SWP
10	Universal Joint	SS400

●Weight: about 2.2kg (Max.L=1000)

NL-8BA (Reinforcing rubber)

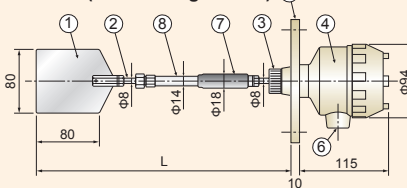

1	Paddle	304SS
2	Main Shaft	304SS
3	Sealcap	C3604
4	Housing	AC
5	Flange	AC
6	Conduit Connection	G 1/2
7	Spring	NBR
8	Universal Joint	SS400
9	Protective Tube	SGP

●Weight: about 2.2kg (Max.L=1000)

Protective-tube extension type **NL-8BS**

When the repose angle is greater, there is much build-up on the tank-wall and so on, vertical, horizontal and diagonal mounting can be selected.

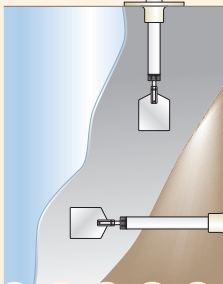
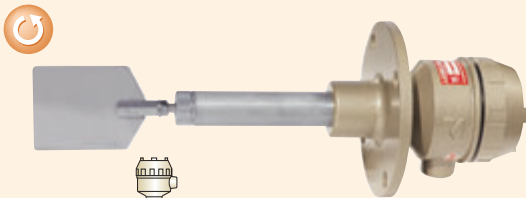

- Flange Size: JIS5K65A equivalent
- Main shaft is protected with protective tube.
- The L dimensions below flange can be made available from over 200mm.
- Sliding flange of the gland packing type can be manufactured.
- Heat resistant type can be available.

NL-8BS (Protective tube extension)

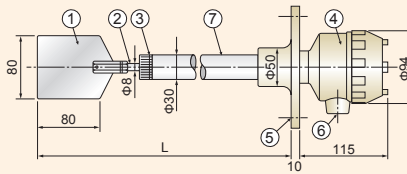

1	Paddle	304SS
2	Main Shaft	304SS
3	Sealcap	C3604
4	Housing	AC
5	Flange	AC
6	Conduit Connection	G 1/2
7	Protective Tube	304SS

●Weight: about 2.0kg (L=200)

NL-8BS (Sliding flange/specified L dimension)

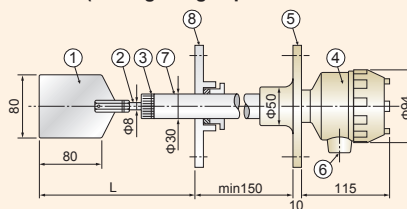

1	Paddle	304SS
2	Main Shaft	304SS
3	Sealcap	C3604
4	Housing	AC
5	Flange	AC
6	Conduit Connection	G 1/2
7	Protective Tube	304SS
8	Sliding Flange	SS400

Heat Resistant Type

NL-8BH

Operating temperature in a tank:250°C. Optional air or water cooled type can operate at the higher temperature.
 ●Flange size: JIS5K65A equivalent

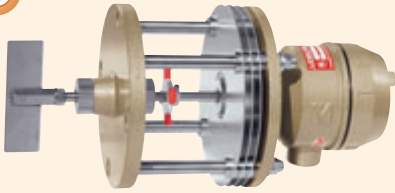

NL-8BH (Standard)

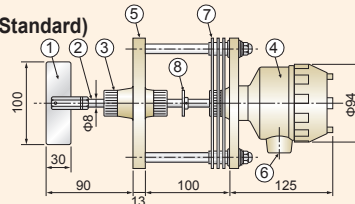

1	Paddle	304SS
2	Main Shaft	304SS
3	Sealcap	C3604
4	Housing	AC
5	Flange	SS400
6	Conduit Connection	G 1/2
7	Radiation Fin	ALP
8	Rotation Check Board	AC

●Weight: about 4.4kg

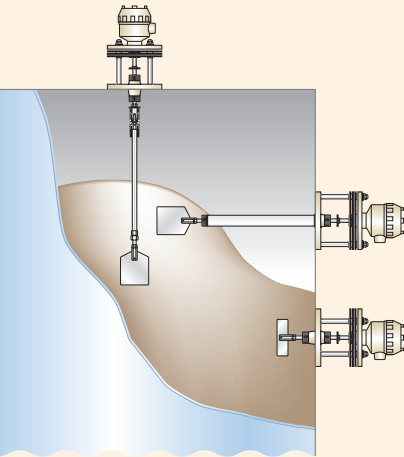

NL-8BHA (Shaft-length Adjustable Type)

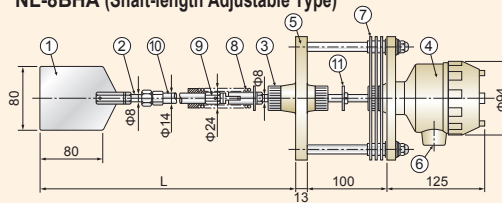

1	Paddle	304SS
2	Main Shaft	304SS
3	Sealcap	C3604
4	Housing	AC
5	Flange	SS400
6	Conduit Connection	G 1/2
7	Radiation Fin	ALP
8	Spring	SWP
9	Universal Joint	SS400
10	Protective Tube	SGP
11	Rotation Check Board	AC

NL-8BHS (Protective Tube Extension Type)

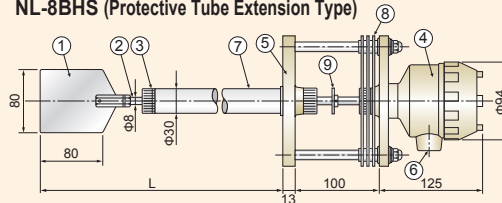

1	Paddle	304SS
2	Main Shaft	304SS
3	Sealcap	C3604
4	Housing	AC
5	Flange	SS400
6	Conduit Connection	G 1/2
7	Protective Tube	304SS
8	Radiation Fin	ALP
9	Rotation Check Board	AC

Withstand Load Type

NL-15B

Lower limit detection of a large tank. Level switch of withstand load type, mounted in a lower part of silo.
 Both heat resistant and protective tube extension type can be manufactured.
 ●Flange size: JIS5K65A equivalent

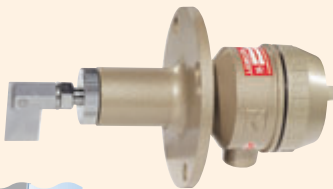

NL-15BS (Protective Tube Extension Type)

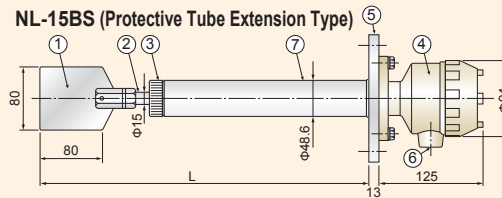

1	Paddle	304SS
2	Main Shaft	304SS
3	Sealcap	C3604
4	Housing	AC
5	Flange	SS400
6	Conduit Connection	G 1/2
7	Protective Tube	304SS

NL-15B (Standard)

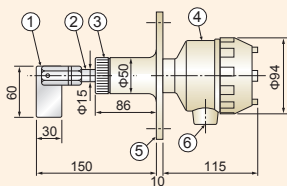

1	Paddle	304SS
2	Main Shaft	304SS
3	Sealcap	C3604
4	Housing	AC
5	Flange	AC
6	Conduit Connection	G 1/2

●Weight: about 2.2kg

NL-15BH (Heat resistant)

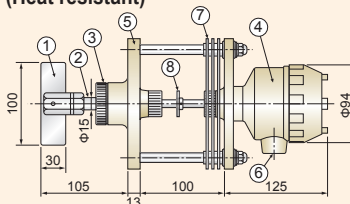

1	Paddle	304SS
2	Main Shaft	304SS
3	Sealcap	C3604
4	Housing	AC
5	Flange	SS400
6	Conduit Connection	G 1/2
7	Radiation Fin	ALP
8	Rotation Check Board	AC

NL-15BY (Protective cover)

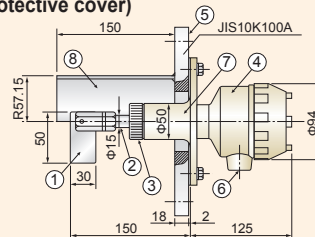

1	Paddle	304SS
2	Main Shaft	304SS
3	Sealcap	C3604
4	Housing	AC
5	Flange	SS400
6	Conduit Connection	G 1/2
7	Boss	AC
8	Protective Cover	SGP

Inner Tank Hanging Type

NL-8DA

Suspended in a tank with 40A pipe. Can be used under varied conditions.

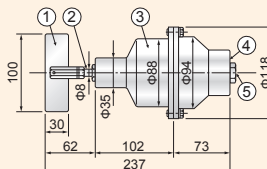
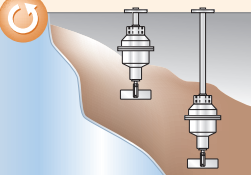

1	Paddle	304SS
2	Main Shaft	304SS
3	Housing	AC
4	Mounting Screw	G1-1/2
5	Conduit Connection	G 1/2

●Suspend it in a tank with 40A pipe.
 ●Advise us of the length of lead cable. (Standard 350mm)
 ●Weight: about 1.3kg

Rotary Paddle Type
model **NM**

Thorough standardization of parts makes budget-priced.

(Wetted parts can be made of 304SS or 316SS)



Standard Flange Type NM-8B Basic Model of NM

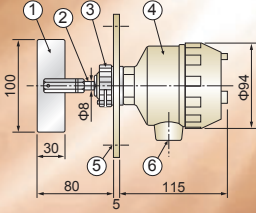

1	Paddle	304SS
2	Main Shaft	304SS
3	Nut	ADC
4	Housing	ADC
5	Flange	SS400
6	Conduit Connection	G 1/2

- Flange size: JIS5K65A equivalent
- Flange of non-standard size can be manufactured (Over JIS5K65A).
- Screwed joint (G1B) with the flange taken off.
- Weight: about 1.65kg

Screwed Joint Type NM-SC Small Hopper Level Switch

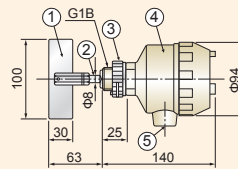

1	Paddle	304SS
2	Main Shaft	304SS
3	Nut	ADC
4	Housing	ADC
5	Conduit Connection	G 1/2

- Mounting G1B
- Weight: about 1.1kg
- *Make the tank diameter $\Phi 34$ in mounting NM-SC.
- *The outside diameter of crown nut is $\Phi 48$.

Adjustable Shaft Type NM-8BA Vertical Mounting

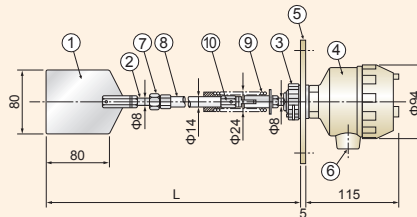
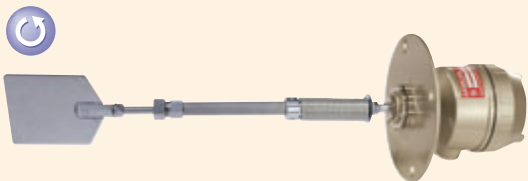

1	Paddle	304SS
2	Main Shaft	304SS
3	Nut	ADC
4	Housing	ADC
5	Flange	SS400
6	Conduit Connection	G 1/2
7	Lock Nut	C3604
8	Protective Tube	SGP
9	Spring	SWP
10	Universal Joint	SS400

- Flange size: JIS5K65A equivalent
- Heat resistant type can be available.
- Weight: about 2.0kg (L=Max.500)

Protective-tube extension type NM-8BS Adjust the L dimensions by sliding flange

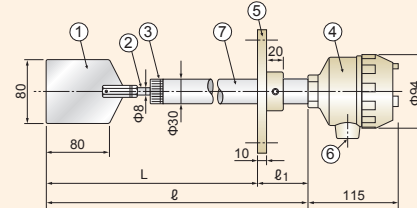
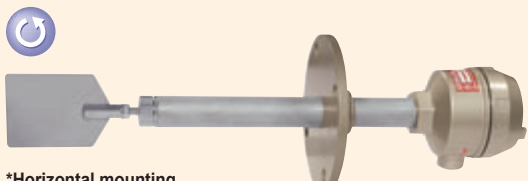

1	Paddle	304SS
2	Main Shaft	304SS
3	Sealcap	C3604
4	Housing	ADC
5	Flange	AC
6	Conduit Connection	G 1/2
7	Protective Tube	304SS

- The L dimensions below flange can be made from over 200mm.
- Heat resistant type can be available.
- Weight: about 2.2kg (L=200)

Heat Resistant Type NM-8BH Operating temperature in a tank: below 180°C

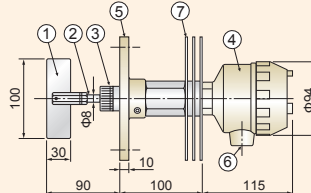
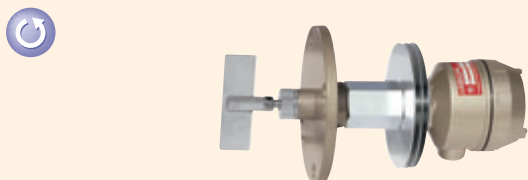

1	Paddle	304SS
2	Main Shaft	304SS
3	Sealcap	C3604
4	Housing	ADC
5	Flange	AC
6	Conduit Connection	G 1/2
7	Radiation Fin	ALP

- Flange size: JIS5K65A equivalent
- The L dimensions below flange can be extended up to 200mm.
- Both Shaft-length adjustable and protective tube extension types can be available.
- Weight: about 2.7kg

Diagonal Flange Type NM-8BN(S) Best to mount at the conical area directly.

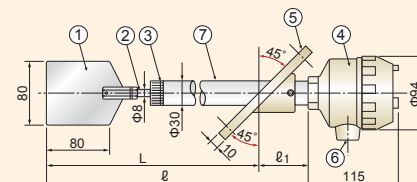

1	Paddle	304SS
2	Main Shaft	304SS
3	Sealcap	C3604
4	Housing	ADC
5	Flange	AC
6	Conduit Connection	G 1/2
7	Protective Tube	304SS

- Flange size: JIS5K65A equivalent
- The standard angle is 45°
- *It is possible to specify the angle.
- Weight: about 2.2kg (L=200)

Rotary Paddle Type
model FL-GM

Various models of Explosion-proof

Flame-proof
d2G4
Certified No. T25642

1	Paddle	304SS
2	Main Shaft	304SS
3	Housing	AC
4	Flange	AC
5	Conduit Connection	G 1/2

- Compact, lightweight, easy to handle.
- Weight: about 4.1kg

Standard FL-GM Basic Model of FL-GM

Adjustable Shaft Type FL-GMA Vertical mounting

Flame-proof
d2G4
Certified No. T25642

1	Paddle	304SS
2	Main Shaft	304SS
3	Housing	AC
4	Flange	AC
5	Conduit Connection	G 1/2
6	Lock Nut	C3604
7	Protective Tube	SGP
8	Spring	SWP
9	Universal Joint	SS400

- Flange size: JIS5K65A equivalent
- Heat resistant type can be available.
- Weight: about 4.5kg (L=Max500)

Protective-tube extension type FL-GMS Can be mounted vertically, horizontally and diagonally.

Flame-proof
d2G4
Certified No. T25642

1	Paddle	304SS
2	Main Shaft	304SS
3	Sealcap	C3604
4	Housing	AC
5	Flange	SS400
6	Conduit Connection	G 1/2
7	Protective Tube	304SS
8	Boss	SS400

- Flange size: JIS5K65A equivalent
- Heat resistant type can be available.
- The L dimensions below flange can be made from over 200mm.

Heat Resistant Type FL-GMH Operating temperature in a tank:250°C

Flame-proof
d2G4
Certified No. T25642

1	Paddle	304SS
2	Main Shaft	304SS
3	Housing	AC
4	Flange	SS400
5	Conduit Connection	G 1/2
6	Radiation Fin	ALP
7	Rotation Check Board	AC

- Flange size: JIS5K65A equivalent.
- Heat resistant type can be available.
- The L dimensions below flange can be extended up to 200mm.
- Both Shaft-length adjustable and protective tube extension types can be available.

Removal of expendable mechanical parts from an internal motor comes up with a long life surpassing other Rotary Paddle Type level switches as well as the stability.

Reversible Paddle Type

NNL/NNM Series

It is highly effective in such processes as excessive On/Off operations.

Flowing materials to be measured.

Fast powder replacement for a small tank.

These processes often require the level switch's detecting operations, thus curtailing the life of the motor extremely. These series, however, secure the long life of the motor unit.

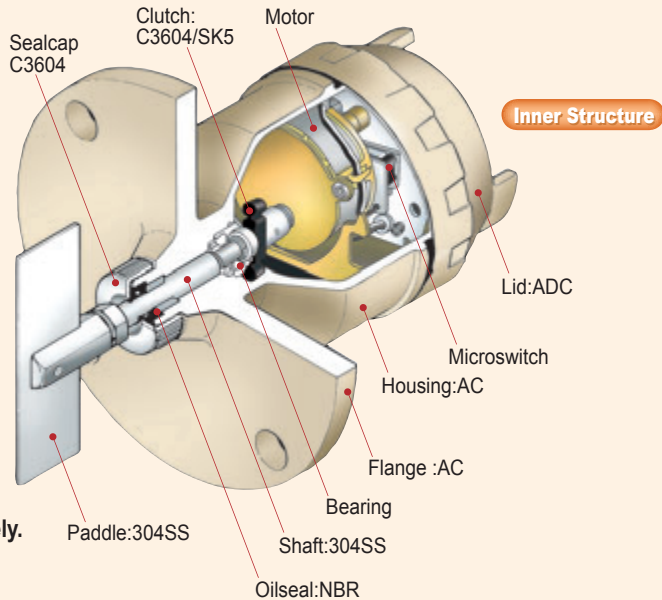

Principle of Operation

Utilizing the switching system we developed on the basis of our experiences and accomplishments in the market, it has offered the highly stable and reliable detection regardless of its paddle rotating direction. A rotating paddle, being loaded by sediments in a tank, activates a micro switch and brings contact output and motor rotation to a halt at the same time. With no load by sediments, the motor resumes rotation. When the paddle is overloaded or suffer strong shock, a clutch system prevents the motor from being broken by letting out excessive load and shock.



Standard Specification

- Power Source** : 100 –110VAC or 200–220VAC 50/60Hz
- Power Consumption** : 4W
- Contact Capacity** : 250VAC 3A Resistance Load
- Rate of Rotation** : 1r.p.m/50Hz
- Allowable Temperature** : below 50°C (in a tank)
- Withstand Voltage** : 1500VAC one minute for in between terminal and housing
- Detection Torque** : about 1000–2800N · m × 10⁻⁴
- Allowable Pressure** : 19.6kPa
- Color** : Gold
- Process Connection** : G1B or Equivalent to JIS 5K 65A
- Enclosure Rating** : IP55 or equivalent

Inner Components

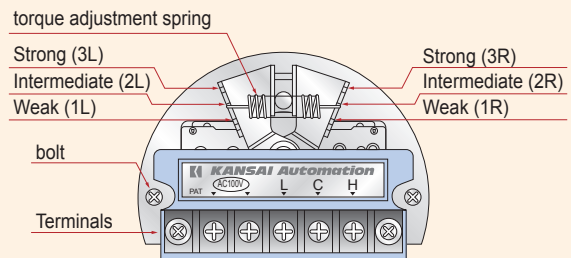

Wiring Diagram

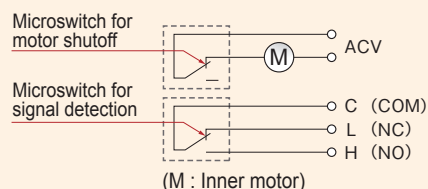

Reversible Paddle Type
model **NNL**

Basic Model of Reversible Rotary-paddle Type,
longer lasting and highly stable.

(Wetted parts can be made of 304SS or 316SS)

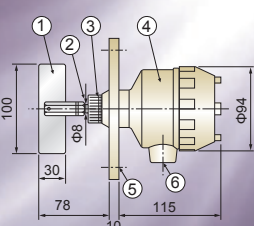



1	Paddle	304SS
2	Shaft	304SS
3	Sealcap	C3604
4	Housing	AC
5	Flange	AC
6	Conduit Connection	G 1/2

- Flange size: JIS5K65A equivalent
- The L dimensions below flange can be extended up to 200mm.
- Weight: about 1.65kg

Standard Flange Type NNL-8B Basic model of MNL

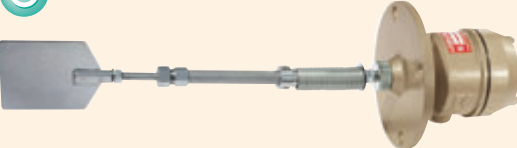
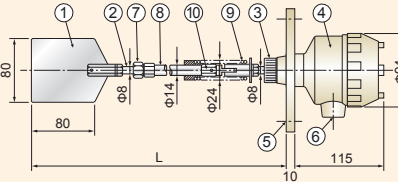
Adjustable Shaft Type NNL-8BA Vertical mounting

1	Paddle	304SS
2	Main Shaft	304SS
3	Sealcap	C3604
4	Housing	AC
5	Flange	AC
6	Conduit Connection	G 1/2
7	Lock Nut	C3604
8	Protective Tube	SGP
9	Spring	SWP
10	Universal Joint	SS400

- Flange size: JIS5K65A equivalent
- Heat resistant type can be manufactured.
- Weight: about 2.2kg (L= Max1000)

Protective-tube extension type NNL-8BS When the repose angle is greater, there is much build-up on the tank-wall and so on, vertical, horizontal and diagonal mounting can be selected.

1	Paddle	304SS
2	Main Shaft	304SS
3	Sealcap	C3604
4	Housing	AC
5	Flange	AC
6	Conduit Connection	G 1/2
7	Protective Tube	304SS

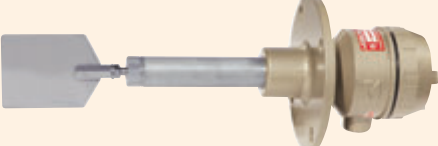
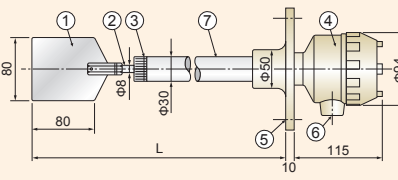
- Flange size: JIS5K65A equivalent
- The L dimensions below flange can be made from over 200mm.
- Sliding flange of the gland packing type can be manufactured.
- Heat resistant type can be available.
- Weight: about 2.0kg (L=200)

Heat Resistant Type NNL-8BH Operating temperature in a tank: below 250°C

1	Paddle	304SS
2	Main Shaft	304SS
3	Sealcap	C3604
4	Housing	AC
5	Flange	SS400
6	Conduit Connection	G 1/2
7	Radiation Fin	ALP
8	Rotation Check Board	AC

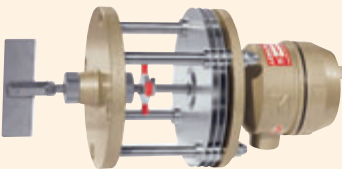
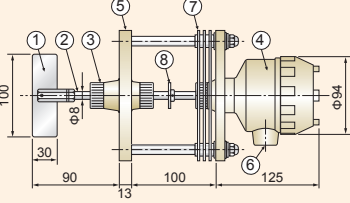
- Flange size: JIS5K65A equivalent
- Special version of max 1000°C
- Both Shaft-length adjustable and protective tube extension types can be available.
- Weight: about 4.4kg

Withstand Load Type NNL-15B Level switch of withstand load type, mounted in a lower part of silo.

1	Paddle	304SS
2	Main Shaft	304SS
3	Sealcap	C3604
4	Housing	AC
5	Flange	AC
6	Conduit Connection	G 1/2

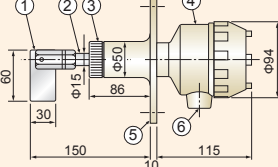
- Flange size: JIS5K65A equivalent
- Heat resistant type and protective tube extension type can be available.
- Weight: about 2.2kg

Inner Tank Hanging Type NNL-8DA Suspended in a tank with 40A pipe.

1	Paddle	304SS
2	Main Shaft	304SS
3	Housing	AC
4	Mounting Screw	G1-1/2
5	Conduit Connection	G 1/2

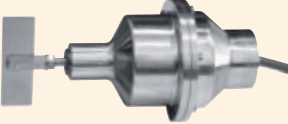
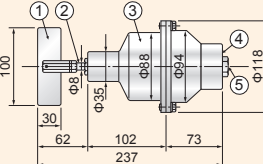
- Advise us of the length of lead cable. (Standard 350mm)
- Weight: about 1.3kg

Reversible Paddle Type
model NNM

Budget-priced Model of Reversible Rotary-paddle Type.

(Wetted parts can be made of 304SS or 316SS)

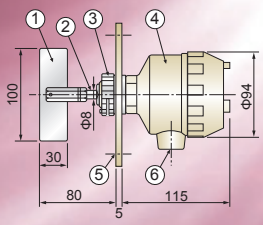



1	Paddle	304SS
2	Main Shaft	304SS
3	Nut	ADC
4	Housing	ADC
5	Flange	SS400
6	Conduit Connection	G 1/2

- Flange size: JIS5K65A equivalent
- Flange of non-standard size can be manufactured (Over JIS5K65A).
- Screwed joint (G1B) with the flange taken off.
- Weight: about 1.65kg

Standard Flange Type NNM-8B Basic Model of NNM

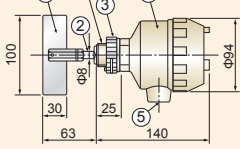
Screwed Joint Type NNM-SC Small Hopper Level Switch

1	Paddle	304SS
2	Main Shaft	304SS
3	Nut	ADC
4	Housing	ADC
5	Conduit Connection	G 1/2

- Mounting G1B
- Weight: about 1.1kg
- *Make the tank diameter $\phi 34$ in mounting NNM-SC.
- *The outside diameter of crown nut is $\phi 48$.

Adjustable Shaft Type NNM-8BA Vertical Mounting

1	Paddle	304SS
2	Main Shaft	304SS
3	Nut	ADC
4	Housing	ADC
5	Flange	SS400
6	Conduit Connection	G 1/2
7	Lock Nut	C3604
8	Protective Tube	SGP
9	Spring	SWP
10	Universal Joint	SS400

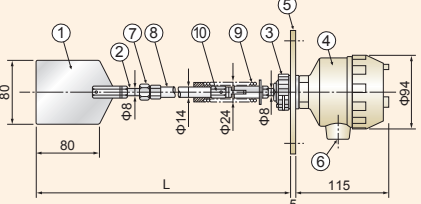
- Flange size: JIS5K65A equivalent
- Heat resistant type can be available.
- Weight: about 2.0kg (L=Max.500)

Protective-tube extension type NNM-8BS Adjust the L dimensions by sliding flange

1	Paddle	304SS
2	Main Shaft	304SS
3	Sealcap	C3604
4	Housing	ADC
5	Flange	AC
6	Conduit Connection	G 1/2
7	Protective Tube	304SS

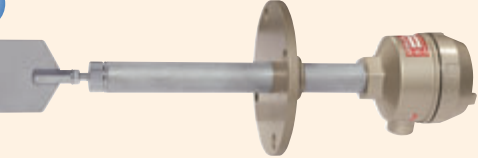
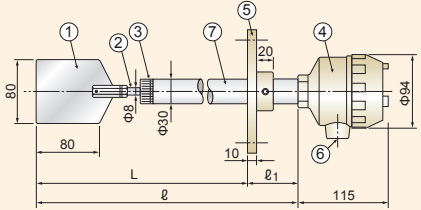
- Flange size: JIS5K65A equivalent
- The L dimensions below flange can be made from over 200mm.
- Heat resistant type can be available.
- Weight: about 2.2kg (L=200)

Heat Resistant Type NNM-8BH Operating temperature in a tank: below 180°C

1	Paddle	304SS
2	Main Shaft	304SS
3	Sealcap	C3604
4	Housing	ADC
5	Flange	AC
6	Conduit Connection	G 1/2
7	Radiation Fin	ALP

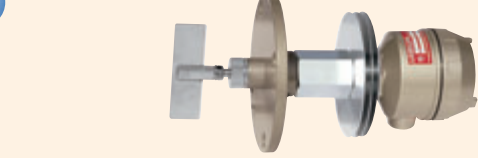
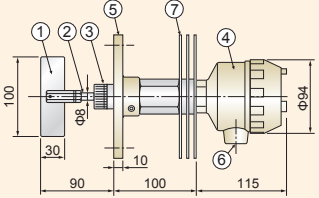
- Flange size: JIS5K65A equivalent
- The L dimensions below flange can be extended up to 200mm.
- Both Shaft-length adjustable and protective tube extension types can be available.
- Weight: about 2.7kg

Diagonal Flange Type NNM-8BN(S) Best to mount at the conical area directly.

1	Paddle	304SS
2	Main Shaft	304SS
3	Sealcap	C3604
4	Housing	ADC
5	Flange	AC
6	Conduit Connection	G 1/2
7	Protective Tube	304SS

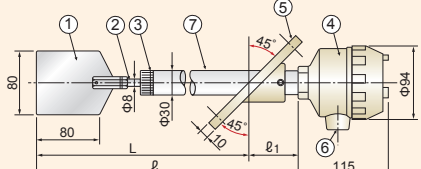
- Flange size: JIS5K65A equivalent
- The standard angle is 45°
- *It is possible to specify the angle.
- Weight: about 2.2kg (L=200)

Paddle Shape

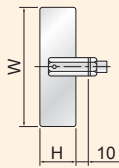

Type A

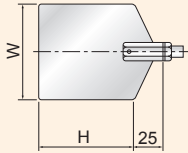

Type B

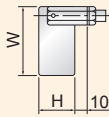

Type C

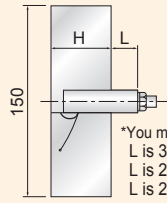

Type D

Special Unfolding Paddle

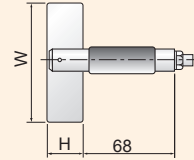

Type F

With flexible shaft

*You may note:
L is 31 when H is 50.
L is 26 when H is 60.
L is 23 when H is 80.

Paddle No.	W×H (mm)	Shape	when not specified
1	80×30	A	8B, Type-A (100×30) 8BA, Type B (80×80) *NNL/NNM model common spec.
2	100×30	A (Standard)	
3	128×25	A	
4	140×30	A	
5	128×80	A	
6	80×80	B (Standard)	
7	128×60	B	
8	60×30	C (Standard)	
9	150×50	D	

No.	Shape	W×H (mm)	Min Specific Gravity
			NL Model
1	A	80×30	2.81
2	A	100×30	1.44
3	A	128×25	0.83
4	A	140×30	0.53
5	A	128×80	0.26
6	B	80×80	1.06
7	B	128×60	0.35
8	C	60×30	1.44

*In case of light gravity, products of cross-paddle type or unfolding-paddle type can be manufactured.

*Paddles other than listed above can be manufactured.

H dimensions of unfolding paddle should be 50 as the minimum.

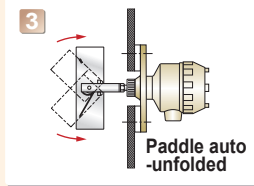
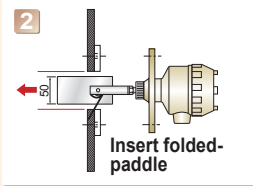
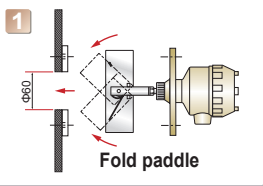

Even if the unfolding paddle is made larger to measure low specific gravity products, it is possible to attach it on a tank without any special modifications, depending on the structure of the paddle. (Possibly make the bore diameter larger than $\Phi 60$)

L Dimensions Table

(Shaft-length Adjustable Type/NL)

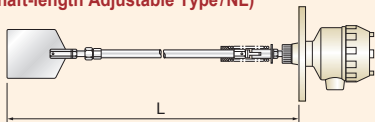

No.	Max dim.(mm)	Min Dim.(mm)	No.	Max dim.(mm)	Min Dim.(mm)
1	500	374	5	2,500	1,374
2	1,000	624	6	3,000	1,624
3	1,500	874	7	4,000	2,124
4	2,000	1,124	8	5,000	2,624

L Dimensions (Protective-tube Extension Type)

NM-8BS
NNM-8BS

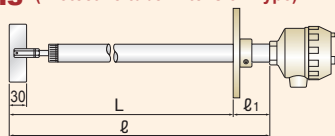

- L dimensions of standard stock are 200, 300, 1000 only.
- With regard to L-dimensions other than listed above, you may use a longer one by one size and slide the flange toward the paddle as necessary. Accordingly ℓ_1 gets longer to the extent
- When a specific dimension paddle is used, you may basically slide the flange in the same manner as described in the item 2.
- Products whose length of L is over 1000 may be manufactured upon request.

NM-8BHS
NNM-8BHS

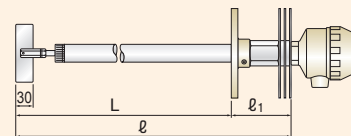

- L dimensions of standard stock are 200, 300, 1000 only.
- With regard to L-dimensions other than listed above, you may use a longer one by one size and slide the flange toward the paddle as necessary. Accordingly ℓ_1 gets longer to the extent
- When a specific dimension paddle is used, you may basically slide the flange in the same manner as described in the item 2.
- Products whose length of L is over 1000 may be manufactured upon request.

Length shape below flange	Paddle shape A 100×30		Length shape below flange	Paddle shape B 80×80	
	L	ℓ_1		L	ℓ_1
135~200 (200)	230	230-L (30)	200~265 (200)	295	295-L (95)
201~300 (300)	330	330-L (30)	266~365 (300)	395	395-L (95)
301~400 (400)	430	430-L (30)	366~465 (400)	495	495-L (95)
401~500 (500)	530	530-L (30)	466~565 (500)	595	595-L (95)
501~600 (600)	630	630-L (30)	566~665 (600)	695	695-L (95)
601~700 (700)	730	730-L (30)	666~765 (700)	795	795-L (95)
701~800 (800)	830	830-L (30)	766~865 (800)	895	895-L (95)
801~900 (900)	930	930-L (30)	866~965 (900)	995	995-L (95)
901~1000 (1000)	1030	1030-L (30)	966~1065 (1000)	1095	1095-L (95)

Length shape below flange	Paddle shape A 100×30		Length shape below flange	Paddle shape B 80×80	
	L	ℓ_1		L	ℓ_1
135~200 (200)	300	300-L (100)	200~265 (200)	365	365-L (165)
201~300 (300)	400	400-L (100)	266~365 (300)	465	465-L (165)
301~400 (400)	500	500-L (100)	366~465 (400)	565	565-L (165)
401~500 (500)	600	600-L (100)	466~565 (500)	665	665-L (165)
501~600 (600)	700	700-L (100)	566~665 (600)	765	765-L (165)
601~700 (700)	800	800-L (100)	666~765 (700)	865	865-L (165)
701~800 (800)	900	900-L (100)	766~865 (800)	965	965-L (165)
801~900 (900)	1000	1000-L (100)	866~965 (900)	1065	1065-L (165)
901~1000 (1000)	1100	1100-L (100)	966~1065 (1000)	1165	1165-L (165)

Type Designation

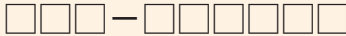

Type of Detection Unit

- S Protective-tube extension type
- F Flexible shaft type
- A Adjustable Shaft Type
- Y Protective cover type
- H Heat resistant type
- N Diagonal flange type

Type of Body

- 8B Main Shaft $\Phi 8$
- 10B Main Shaft $\Phi 10$
- 15B Main Shaft $\Phi 15$
- GM Withstand-pressure explosion-proof, Cable-conduit threaded
- SC Screwed-joint (small hopper) (Shaft $\Phi 8$ or $\Phi 10$)
- DA Inner Tank Hanging Type
(with 5-core cable in 350mm long for external connection)

Name of Series

- NL } Standard Model
- NM } Standard Model
- FL } Explosion-proof
- NNL } Reversible Model
- NNM } Reversible Model

Paddle Mounting

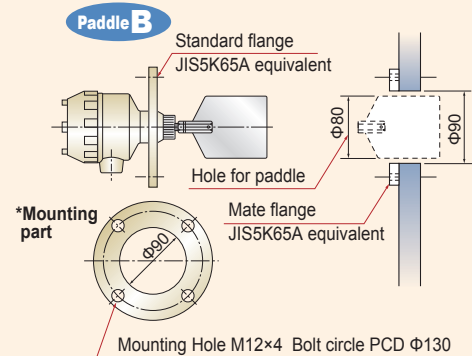
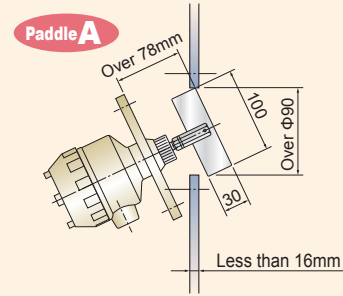

Lightweight and budget price as well as quality and high performance!

You can put on a tank with no removing the paddle from the unit.
A folding paddle is a standard equipment.

Mini Rotary paddle Type Level Switch

LEMICON-S Palm-size



Standard Specification

Power Source : 100–110VAC or 200–220VAC 50/60Hz
Power Consumption : 1.5W
Contact Capacity : 250VAC 3A (Resistance Load, SPDT)
Rate of Rotation : 0.83r.p.m.(50Hz) / 1.00r.p.m.(60Hz)
Rotation Direction : Clockwise (Viewing from paddle)
Allowable Temperature : 0–50°C (no freezing) Heat resistant (0–120°C)

Withstand Voltage : 1500VAC one minute

Detection Torque : 170–270N · m $\times 10^{-4}$

Color : Gold

Setscrew : G 3/4B (material ADC)

Locknut : Hexagonal nut (opposite side 35mm, thickness 10mm, material ADC)

Cable length : 500mm (max)

*Wetted parts made of stainless steel can be available.

Line of business

- Rotary Paddle Type Level Switch
- Vibration Type Level Switch
- Swing Type Level Switch
- Acoustic Level Switch
- Capacitance Type Level Switch
- Capacitive Proximity Sensor
- Capacitance Type Level Indicator
- Diaphragm Type Level Switch
- Tiit Switch
- Leak Type Level Switch
- Microwave Type Switch
- Sounding Bob Type Level Indicator
- Flow Switch
- Conductance Type Level Switch
- Float Switch
- Float Type Level Indicator
- Ultrasonic Type Level Indicator
- Equipments For Conveyor Lines
- Dust Monitor System
- Zirconia Oxygen Analyzer
- Laser Type Level Indicator
- RADAR Type Level Indicator
- On-line Sensors for Accurate Liquid Analysis
- Ultrasonic Flow meter

*Please be sure to read USER'S GUIDE, Installation & Operation Instructions before using the instrument.

*The specifications herein may be subject to change without advance notice.

Nuclear Power Generation to Rice Milling
All-round Manufacturer of Level Controllers for Powder, Granules and Liquid

KANSAI Automation Co., Ltd.

Headquarters :
2-14, Togano-cho, Kita-ku, Osaka 530-0056, Japan
TEL. 81-6-6312-2071 FAX. 81-6-6314-0848
e-mail: info@kansai-automation.co.jp

<http://www.kansai-automation.co.jp>

Tokyo Branch : 1-29-6, Hamamatsu-cho, Minato-ku, Tokyo 105-0013, Japan
TEL. 81-3-5777-6931 FAX. 81-3-5777-6933

Nagoya Office : 3-31-27, Uchiyama, Chigusa-ku, Nagoya 464-0075, Japan
TEL. 81-52-741-2432 FAX. 81-52-741-1588

Kyushu Office : 1-2-39, Asano, Kokura Kita-ku, Kitakyushu 802-0001, Japan
TEL. 81-93-511-4741 FAX. 81-93-511-4580



Agent